

EcoWater Systems LLC

COMMERCIAL SERIES WATER SOFTENERS – 2" VALVE

NOTE: All models shipped unassembled. Shipping weights are approximate.

MODEL	RESIN TANK	SHIPPING WEIGHT
EWS102S	17" x 58" P/N 7149994	440#
EWS102S-1	16" x 65" P/N 7391787	
EWS132S	17" x 58" P/N 7149994	500#
EWS132S-1	16" x 65" P/N 7391787	

MODEL	RESIN TANK	SHIPPING WEIGHT
EWS102D	17" x 58" P/N 7149994	850#
EWS102D-1	16" x 65" P/N 7391787	
EWS132D	17" x 58" P/N 7149994	960#
EWS132D-1	16" x 65" P/N 7391787	

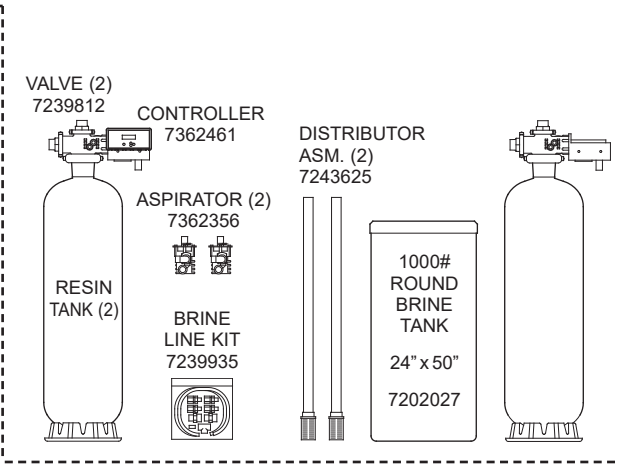
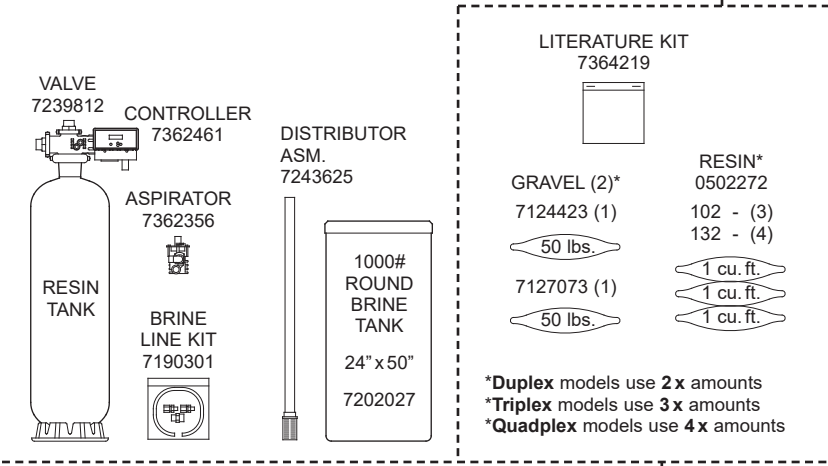

MODEL	RESIN TANK	SHIPPING WEIGHT
EWS102T	17" x 58" P/N 7149994	1290#
EWS102T-1	16" x 65" P/N 7391787	
EWS132T	17" x 58" P/N 7149994	1450#
EWS132T-1	16" x 65" P/N 7391787	

MODEL	RESIN TANK	SHIPPING WEIGHT
EWS102Q	17" x 58" P/N 7149994	1780#
EWS102Q-1	16" x 65" P/N 7391787	
EWS132Q	17" x 58" P/N 7149994	1870#
EWS132Q-1	16" x 65" P/N 7391787	

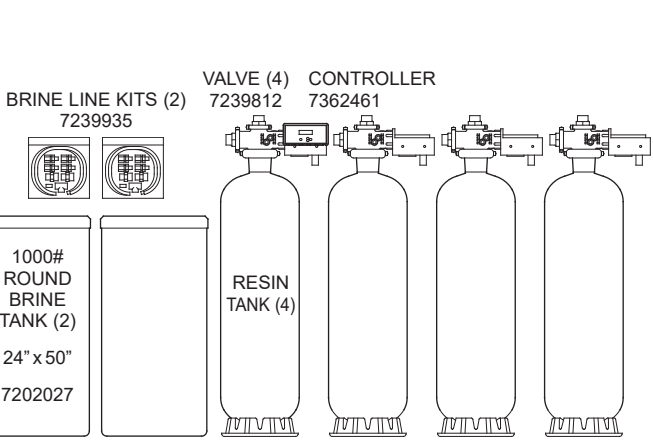
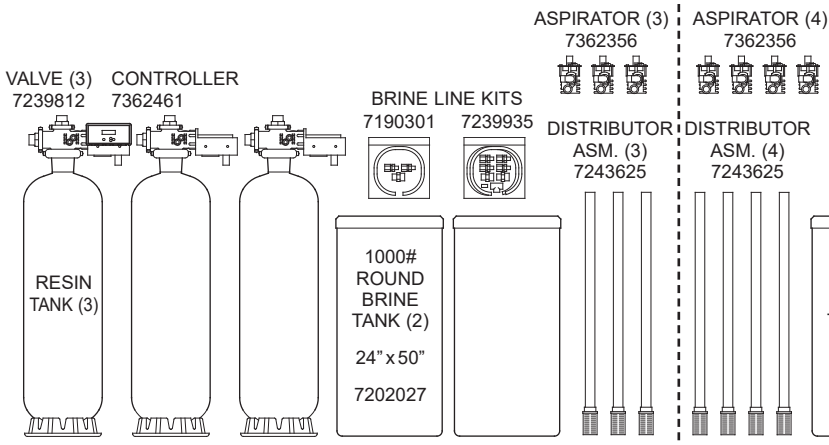

EcoWater Systems LLC

COMMERCIAL SERIES WATER SOFTENERS – 2" VALVE

NOTE: All models shipped unassembled. Shipping weights are approximate.

MODEL	RESIN TANK	SHIPPING WEIGHT
EWS162S	17" x 72" P/N 7153561	600#
EWS162S-1	18" x 65" P/N 7391795	

MODEL	RESIN TANK	SHIPPING WEIGHT
EWS162D	17" x 72" P/N 7153561	1090#
EWS162D-1	18" x 65" P/N 7391795	

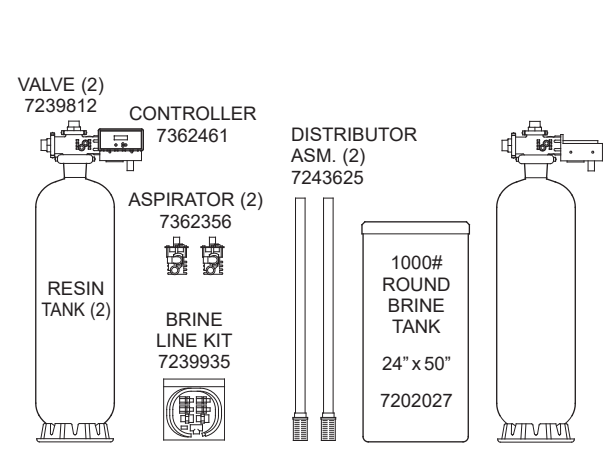
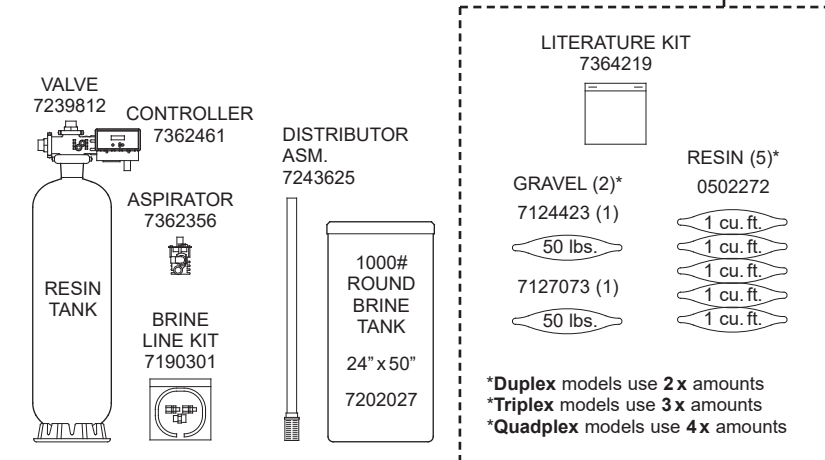

MODEL	RESIN TANK	SHIPPING WEIGHT
EWS162T	17" x 72" P/N 7153561	1640#
EWS162T-1	18" x 65" P/N 7391795	

MODEL	RESIN TANK	SHIPPING WEIGHT
EWS162Q	17" x 72" P/N 7153561	2130#
EWS162Q-1	18" x 65" P/N 7391795	

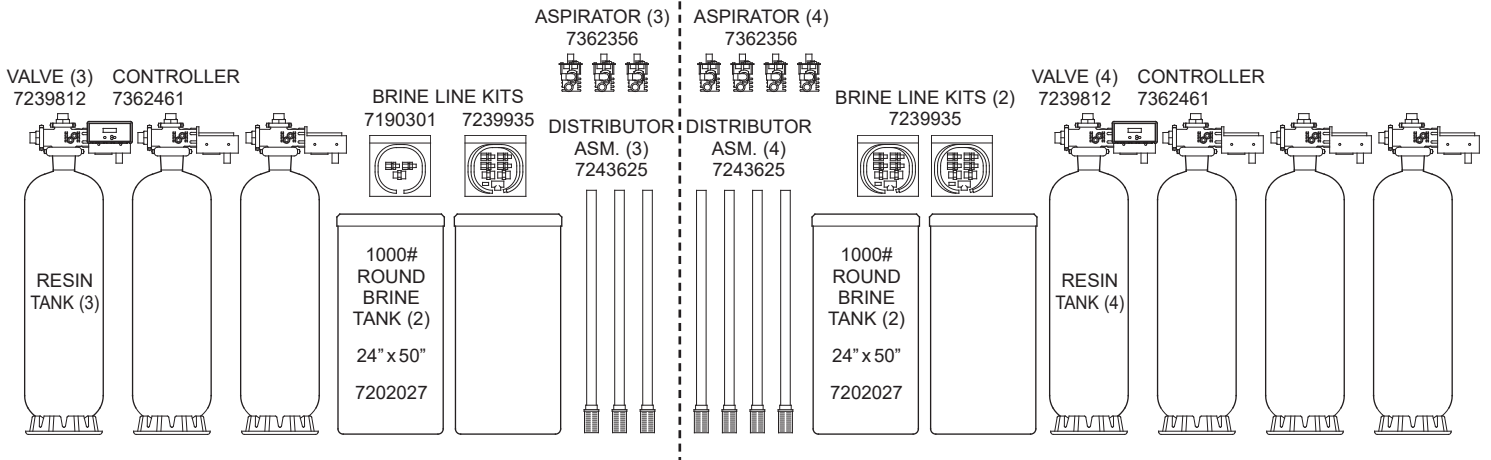

EcoWater Systems LLC

COMMERCIAL SERIES WATER SOFTENERS – 2" VALVE

NOTE: All models shipped unassembled. Shipping weights are approximate.

MODEL	RESIN TANK	SHIPPING WEIGHT
EWS192S	24" x 72" P/N 7298777	820#
EWS192S-1	24" x 72" P/N 7391800	
EWS252S	24" x 72" P/N 7298777	920#
EWS252S-1	24" x 72" P/N 7391800	
EWS322S	24" x 72" P/N 7298777	1030#
EWS322S-1	24" x 72" P/N 7391800	

MODEL	RESIN TANK	SHIPPING WEIGHT
EWS192D	24" x 72" P/N 7298777	1490#
EWS192D-1	24" x 72" P/N 7391800	
EWS252D	24" x 72" P/N 7298777	1710#
EWS252D-1	24" x 72" P/N 7391800	
EWS322D	24" x 72" P/N 7298777	1920#
EWS322D-1	24" x 72" P/N 7391800	

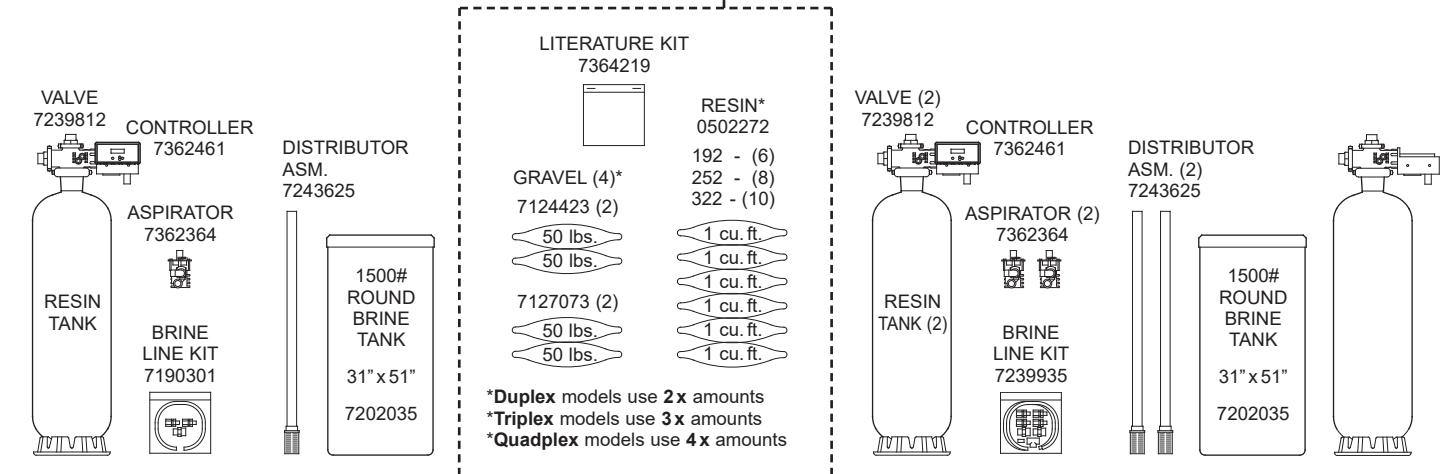

MODEL	RESIN TANK	SHIPPING WEIGHT
EWS192T	24" x 72" P/N 7298777	2260#
EWS192T-1	24" x 72" P/N 7391800	
EWS252T	24" x 72" P/N 7298777	2590#
EWS252T-1	24" x 72" P/N 7391800	
EWS322T	24" x 72" P/N 7298777	2910#
EWS322T-1	24" x 72" P/N 7391800	

MODEL	RESIN TANK	SHIPPING WEIGHT
EWS192Q	24" x 72" P/N 7298777	2940#
EWS192Q-1	24" x 72" P/N 7391800	
EWS252Q	24" x 72" P/N 7298777	3410#
EWS252Q-1	24" x 72" P/N 7391800	
EWS322Q	24" x 72" P/N 7298777	3840#
EWS322Q-1	24" x 72" P/N 7391800	

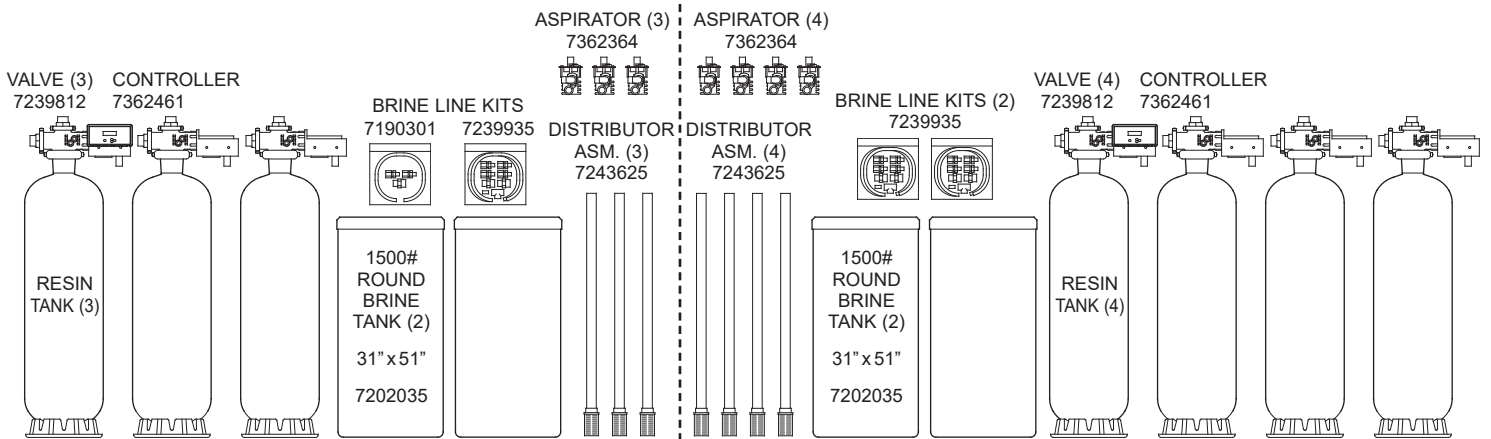

EcoWater Systems LLC

COMMERCIAL SERIES WATER SOFTENERS – 2" VALVE

NOTE: All models shipped unassembled. Shipping weights are approximate.

ADAPTOR 7345516
VALVE 7239812
CONTROLLER 7362461
ASPIRATOR 7362372
BRINE LINE KIT 7190301

EWS362S - 1310#
EWS452S - 1470#

DISTRIBUTOR ASM. 7243625

2500# ROUND BRINE TANK 41" x 51" 940027

RESIN TANK 30" x 72" 0403007

LITERATURE KIT 7364219

GRAVEL (6)*
7124423 (3)
1 cu. ft.
1 cu. ft.
1 cu. ft.
7127073 (3)
1 cu. ft.
1 cu. ft.
1 cu. ft.

RESIN* 0502272
362 - (12)
452 - (15)

*Duplex models use 2x amounts
*Triplex models use 3x amounts
*Quadplex models use 4x amounts

ADAPTOR (2) 7345516
VALVE (2) 7239812
CONTROLLER 7362461
ASPIRATOR (2) 7362372
BRINE LINE KIT 7239935

EWS362D - 2480#
EWS452D - 2840#

DISTRIBUTOR ASM. (2) 7243625

2500# ROUND BRINE TANK 41" x 51" 940027

RESIN TANK (2) 30" x 72" 0403007

ADAPTOR (3) 7345516
VALVE (3) 7239812
CONTROLLER 7362461
BRINE LINE KITS 7190301 7239935

EWS362T - 3740#
EWS452T - 4270#

DISTRIBUTOR ASM. (3) 7243625

2500# ROUND BRINE TANK (2) 41" x 51" 940027

RESIN TANK (3) 30" x 72" 0403007

ASPIRATOR (3) 7362372
ASPIRATOR (4) 7362372

DISTRIBUTOR ASM. (4) 7243625

ADAPTOR (4) 7345516
VALVE (4) 7239812
CONTROLLER 7362461
BRINE LINE KITS (2) 7239935

EWS362Q - 4950#
EWS452Q - 5640#

DISTRIBUTOR ASM. (4) 7243625

2500# ROUND BRINE TANK (2) 41" x 51" 940027

RESIN TANK (4) 30" x 72" 0403007

EcoWater Systems LLC

COMMERCIAL SERIES WATER SOFTENERS – 2" VALVE

NOTE: All models shipped unassembled. Shipping weights are approximate.

<p>EWS602S - 1920#</p> <p>ADAPTOR 7345516 </p> <p>VALVE 7239812 </p> <p>CONTROLLER 7362461 </p> <p>ASPIRATOR 7362380 </p> <p>BRINE LINE KIT 7190301 </p> <p>DISTRIBUTOR ASM. 7243625 </p> <p>2500# ROUND BRINE TANK 41" x 51" 940027 </p>	<p>LITERATURE KIT 7364219 </p> <p>GRAVEL (8)* 7124423 (3) </p> <p>1 cu. ft. </p> <p>1 cu. ft. </p> <p>1 cu. ft. </p> <p>7127073 (5) </p> <p>1 cu. ft. </p> <p>1 cu. ft. </p> <p>1 cu. ft. </p> <p>1 cu. ft. </p> <p>1 cu. ft. </p> <p>1 cu. ft. </p>	<p>RESIN (20)* 0502272 </p> <p>1 cu. ft. </p> <p>1 cu. ft. </p> <p>1 cu. ft. </p> <p>1 cu. ft. </p> <p>1 cu. ft. </p> <p>1 cu. ft. </p> <p>1 cu. ft. </p> <p>1 cu. ft. </p> <p>1 cu. ft. </p> <p>1 cu. ft. </p> <p>1 cu. ft. </p> <p>1 cu. ft. </p> <p>1 cu. ft. </p> <p>1 cu. ft. </p> <p>1 cu. ft. </p>	<p>EWS602D - 3700#</p> <p>ADAPTOR (2) 7345516 </p> <p>VALVE (2) 7239812 </p> <p>CONTROLLER 7362461 </p> <p>ASPIRATOR (2) 7362380 </p> <p>BRINE LINE KIT 7239935 </p> <p>DISTRIBUTOR ASM. (2) 7243625 </p> <p>2500# ROUND BRINE TANK 41" x 51" 940027 </p>
<p>*Duplex models use 2x amounts *Triplex models use 3x amounts *Quadplex models use 4x amounts</p>			
<p>EWS602T - 5560#</p> <p>ADAPTOR (3) 7345516 </p> <p>VALVE (3) 7239812 </p> <p>CONTROLLER 7362461 </p> <p>ASPIRATOR (3) 7362380 </p> <p>BRINE LINE KITS 7190301 7239935 </p> <p>DISTRIBUTOR ASM. (3) 7243625 </p> <p>2500# ROUND BRINE TANK (2) 41" x 51" 940027 </p>	<p>ASPIRATOR (4) 7362380 </p> <p>DISTRIBUTOR ASM. (4) 7243625 </p>	<p>ADAPTOR (4) 7345516 </p> <p>BRINE LINE KITS (2) 7239935 </p> <p>2500# ROUND BRINE TANK (2) 41" x 51" 940027 </p>	<p>EWS602Q - 7350#</p> <p>ADAPTOR (4) 7345516 </p> <p>VALVE (4) 7239812 </p> <p>CONTROLLER 7362461 </p> <p>ASPIRATOR (4) 7362380 </p> <p>BRINE LINE KITS (2) 7239935 </p> <p>DISTRIBUTOR ASM. (4) 7243625 </p> <p>2500# ROUND BRINE TANK (2) 41" x 51" 940027 </p>

EcoWater Systems LLC

COMMERCIAL SERIES WATER FILTERS – 2" VALVE

NOTE: All models shipped unassembled. Shipping weights are approximate.

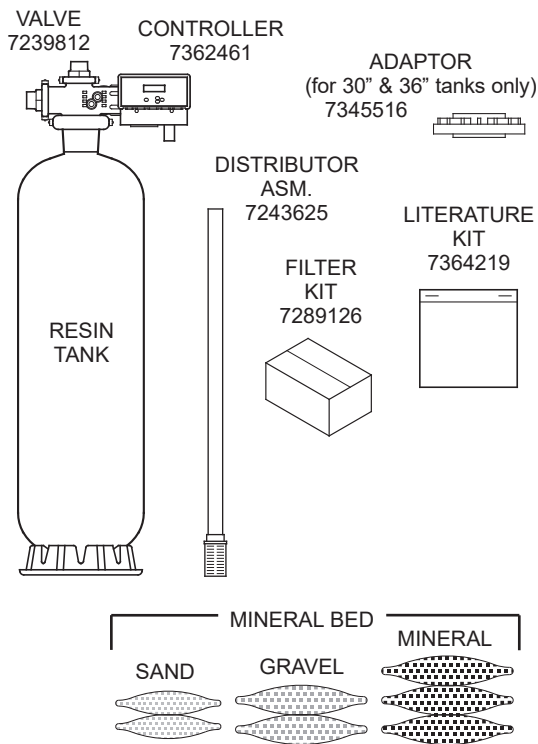

MODEL	RESIN TANK	SHIPPING WEIGHT	MINERAL BED
EWS172XS	17" x 58" P/N 7149994	252#	see table below
EWS172XS-1	16" x 65" P/N 7391787		
EWS242XS	24" x 72" P/N 7298777	358#	
EWS242XS-1	24" x 72" P/N 7391800		
EWS302XS	30" x 72" P/N 0403007	765#	
EWS362XS	36" x 72" P/N 0403006	930#	
EWS172CS	17" x 58" P/N 7149994	420#	
EWS172CS-1	16" x 65" P/N 7391787		
EWS242CS	24" x 72" P/N 7298777	770#	
EWS242CS-1	24" x 72" P/N 7391800		
EWS302CS	30" x 72" P/N 0403007	1185#	
EWS362CS	36" x 72" P/N 0403006	1490#	
EWS172MS	17" x 58" P/N 7149994	560#	
EWS172MS-1	16" x 65" P/N 7391787		
EWS242MS	24" x 72" P/N 7298777	1060#	
EWS242MS-1	24" x 72" P/N 7391800		
EWS302MS	30" x 72" P/N 0403007	1620#	
EWS172GS	17" x 58" P/N 7149994	660#	
EWS172GS-1	16" x 65" P/N 7391787		
EWS242GS	24" x 72" P/N 7298777	1160#	
EWS242GS-1	24" x 72" P/N 7391800		
EWS302GS	30" x 72" P/N 0403007	1780#	

MODEL	GRAVEL 7124423		FILTER SAND 0993080		ACTIVATED CARBON 7336834	GREENSAND PLUS™ 7331101	ANTHRACITE 0993070		GARNET 0993090	
	lbs.	bags	lbs.	bags	1 cu. ft. bags	1/2 cu. ft. bags	lbs.	bags	lbs.	bags
EWS172XS, EWS172XS-1	100	2	–	–	–	–	–	–	–	–
EWS242XS, EWS242XS-1	150	3	–	–	–	–	–	–	–	–
EWS302XS	250	5	–	–	–	–	–	–	–	–
EWS362XS	300	6	–	–	–	–	–	–	–	–
EWS172CS, EWS172CS-1	100	2	–	–	4	–	–	–	–	–
EWS242CS, EWS242CS-1	150	3	–	–	10	–	–	–	–	–
EWS302CS	250	5	–	–	15	–	–	–	–	–
EWS362CS	300	6	–	–	20	–	–	–	–	–
EWS172MS, EWS172MS-1	100	2	100	2	–	–	156	3	50	1
EWS242MS, EWS242MS-1	150	3	250	5	–	–	312	6	150	3
EWS302MS	250	5	350	7	–	–	520	10	200	4
EWS172GS, EWS172GS-1	100	2	–	–	–	6	78*	2*	50	1
EWS242GS, EWS242GS-1	150	3	–	–	–	12	156	3	150	3
EWS302GS	250	5	–	–	–	18	260	5	200	4

Greensand Plus™ is a trademark of Inversand Company.

*1-1/2 of the 2 bags included are used.

EcoWater Systems LLC

COMMERCIAL SERIES WATER FILTERS – 2" VALVE

NOTE: All models shipped unassembled. Shipping weights are approximate.

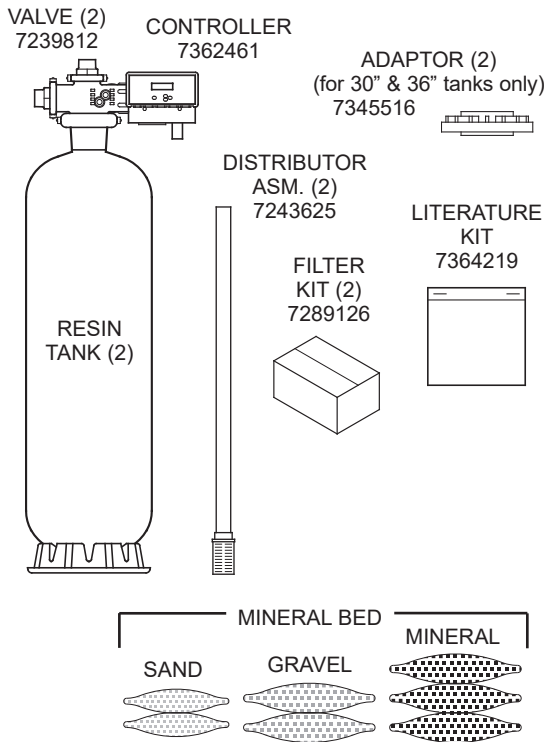

MODEL	RESIN TANK	SHIPPING WEIGHT	MINERAL BED
EWS172XD	17" x 58" P/N 7149994	494#	see table below
EWS172XD-1	16" x 65" P/N 7391787		
EWS242XD	24" x 72" P/N 7298777	680#	
EWS242XD-1	24" x 72" P/N 7391800		
EWS302XD	30" x 72" P/N 0403007	1480#	
EWS362XD	36" x 72" P/N 0403006	1810#	
EWS172CD	17" x 58" P/N 7149994	830#	
EWS172CD-1	16" x 65" P/N 7391787		
EWS242CD	24" x 72" P/N 7298777	1570#	
EWS242CD-1	24" x 72" P/N 7391800		
EWS302CD	30" x 72" P/N 0403007	2320#	
EWS362CD	36" x 72" P/N 0403006	2930#	
EWS172MD	17" x 58" P/N 7149994	1110#	
EWS172MD-1	16" x 65" P/N 7391787		
EWS242MD	24" x 72" P/N 7298777	2110#	
EWS242MD-1	24" x 72" P/N 7391800		
EWS302MD	30" x 72" P/N 0403007	3200#	
EWS172GD	17" x 58" P/N 7149994	1260#	
EWS172GD-1	16" x 65" P/N 7391787		
EWS242GD	24" x 72" P/N 7298777	2320#	
EWS242GD-1	24" x 72" P/N 7391800		
EWS302GD	30" x 72" P/N 0403007	3510#	

MODEL	GRAVEL 7124423		FILTER SAND 0993080		ACTIVATED CARBON 7336834	GREENSAND PLUS™ 7331101	ANTHRACITE 0993070		GARNET 0993090	
	lbs.	bags	lbs.	bags	1 cu. ft. bags	1/2 cu. ft. bags	lbs.	bags	lbs.	bags
EWS172XD, EWS172XD-1	200	4	–	–	–	–	–	–	–	–
EWS242XD, EWS242XD-1	300	6	–	–	–	–	–	–	–	–
EWS302XD	500	10	–	–	–	–	–	–	–	–
EWS362XD	600	12	–	–	–	–	–	–	–	–
EWS172CD, EWS172CD-1	200	4	–	–	8	–	–	–	–	–
EWS242CD, EWS242CD-1	300	6	–	–	20	–	–	–	–	–
EWS302CD	500	10	–	–	30	–	–	–	–	–
EWS362CD	600	12	–	–	40	–	–	–	–	–
EWS172MD, EWS172MD-1	200	4	200	4	–	–	312	6	100	2
EWS242MD, EWS242MD-1	300	6	500	10	–	–	624	12	300	6
EWS302MD	500	10	700	14	–	–	1040	20	400	8
EWS172GD, EWS172GD-1	200	4	–	–	–	12	156	3	100	2
EWS242GD, EWS242GD-1	300	6	–	–	–	24	312	6	300	6
EWS302GD	500	10	–	–	–	36	520	10	400	8

Greensand Plus™ is a trademark of Inversand Company.

EcoWater Systems LLC

COMMERCIAL SERIES WATER FILTERS – 2" VALVE

NOTE: All models shipped unassembled. Shipping weights are approximate.

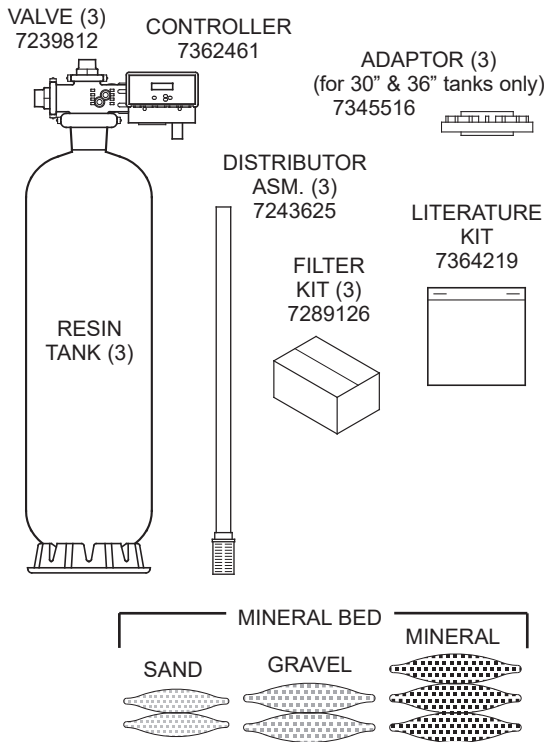

MODEL	RESIN TANK	SHIPPING WEIGHT	MINERAL BED
EWS172XT	17" x 58" P/N 7149994	746#	see table below
EWS172XT-1	16" x 65" P/N 7391787		
EWS242XT	24" x 72" P/N 7298777	1060#	
EWS242XT-1	24" x 72" P/N 7391800		
EWS302XT	30" x 72" P/N 0403007	2240#	
EWS362XT	36" x 72" P/N 0403006	2770#	
EWS172CT	17" x 58" P/N 7149994	1250#	
EWS172CT-1	16" x 65" P/N 7391787		
EWS242CT	24" x 72" P/N 7298777	2320#	
EWS242CT-1	24" x 72" P/N 7391800		
EWS302CT	30" x 72" P/N 0403007	3500#	
EWS362CT	36" x 72" P/N 0403006	4410#	
EWS172MT	17" x 58" P/N 7149994	1660#	
EWS172MT-1	16" x 65" P/N 7391787		
EWS242MT	24" x 72" P/N 7298777	3200#	
EWS242MT-1	24" x 72" P/N 7391800		
EWS302MT	30" x 72" P/N 0403007	4823#	
EWS172GT	17" x 58" P/N 7149994	1920#	
EWS172GT-1	16" x 65" P/N 7391787		
EWS242GT	24" x 72" P/N 7298777	3480#	
EWS242GT-1	24" x 72" P/N 7391800		
EWS302GT	30" x 72" P/N 0403007	5340#	

MODEL	GRAVEL 7124423		FILTER SAND 0993080		ACTIVATED CARBON 7336834	GREENSAND PLUS™ 7331101	ANTHRACITE 0993070		GARNET 0993090	
	lbs.	bags	lbs.	bags	1 cu. ft. bags	1/2 cu. ft. bags	lbs.	bags	lbs.	bags
EWS172XT, EWS172XT-1	300	6	-	-	-	-	-	-	-	-
EWS242XT, EWS242XT-1	450	9	-	-	-	-	-	-	-	-
EWS302XT	750	15	-	-	-	-	-	-	-	-
EWS362XT	900	18	-	-	-	-	-	-	-	-
EWS172CT, EWS172CT-1	300	6	-	-	12	-	-	-	-	-
EWS242CT, EWS242CT-1	450	9	-	-	30	-	-	-	-	-
EWS302CT	750	15	-	-	45	-	-	-	-	-
EWS362CT	900	18	-	-	60	-	-	-	-	-
EWS172MT, EWS172MT-1	300	6	300	6	-	-	468	9	150	3
EWS242MT, EWS242MT-1	450	9	750	15	-	-	936	18	450	9
EWS302MT	750	15	1050	21	-	-	1560	30	600	12
EWS172GT, EWS172GT-1	300	6	-	-	-	18	234*	5*	150	3
EWS242GT, EWS242GT-1	450	9	-	-	-	36	468	9	450	9
EWS302GT	750	15	-	-	-	54	780	15	600	12

Greensand Plus™ is a trademark of Inversand Company.

*4-1/2 of the 5 bags included are used.

EcoWater Systems LLC

COMMERCIAL SERIES WATER FILTERS – 2" VALVE

NOTE: All models shipped unassembled. Shipping weights are approximate.

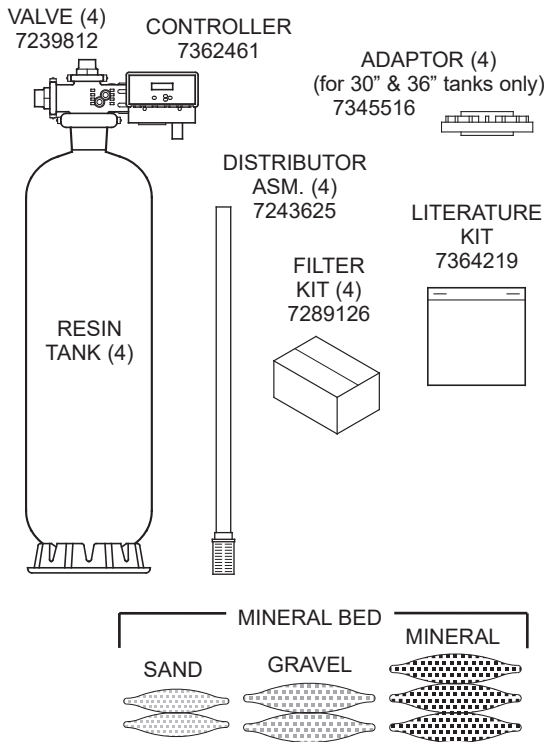

MODEL	RESIN TANK	SHIPPING WEIGHT	MINERAL BED
EWS172XQ	17" x 58" P/N 7149994	988#	see table below
EWS172XQ-1	16" x 65" P/N 7391787		
EWS242XQ	24" x 72" P/N 7298777	1370#	
EWS242XQ-1	24" x 72" P/N 7391800		
EWS302XQ	30" x 72" P/N 0403007	3060#	
EWS362XQ	36" x 72" P/N 0403006	3700#	
EWS172CQ	17" x 58" P/N 7149994	2080#	
EWS172CQ-1	16" x 65" P/N 7391787		
EWS242CQ	24" x 72" P/N 7298777	3050#	
EWS242CQ-1	24" x 72" P/N 7391800		
EWS302CQ	30" x 72" P/N 0403007	4740#	
EWS362CQ	36" x 72" P/N 0403006	5940#	
EWS172MQ	17" x 58" P/N 7149994	2210#	
EWS172MQ-1	16" x 65" P/N 7391787		
EWS242MQ	24" x 72" P/N 7298777	4250#	
EWS242MQ-1	24" x 72" P/N 7391800		
EWS302MQ	30" x 72" P/N 0403007	6360#	
EWS172GQ	17" x 58" P/N 7149994	2520#	
EWS172GQ-1	16" x 65" P/N 7391787		
EWS242GQ	24" x 72" P/N 7298777	4670#	
EWS242GQ-1	24" x 72" P/N 7391800		
EWS302GQ	30" x 72" P/N 0403007	6980#	

MODEL	GRAVEL 7124423		FILTER SAND 0993080		ACTIVATED CARBON 7336834	GREENSAND PLUS™ 7331101	ANTHRACITE 0993070		GARNET 0993090	
	lbs.	bags	lbs.	bags	1 cu. ft. bags	1/2 cu. ft. bags	lbs.	bags	lbs.	bags
EWS172XQ, EWS172XQ-1	400	8	–	–	–	–	–	–	–	–
EWS242XQ, EWS242XQ-1	600	12	–	–	–	–	–	–	–	–
EWS302XQ	1000	20	–	–	–	–	–	–	–	–
EWS362XQ	1200	24	–	–	–	–	–	–	–	–
EWS172CQ, EWS172CQ-1	400	8	–	–	16	–	–	–	–	–
EWS242CQ, EWS242CQ-1	600	12	–	–	40	–	–	–	–	–
EWS302CQ	1000	20	–	–	60	–	–	–	–	–
EWS362CQ	1200	24	–	–	80	–	–	–	–	–
EWS172MQ, EWS172MQ-1	400	8	400	8	–	–	624	12	200	4
EWS242MQ, EWS242MQ-1	600	12	1000	20	–	–	1248	24	600	12
EWS302MQ	1000	20	1400	28	–	–	2080	40	800	16
EWS172GQ, EWS172GQ-1	400	8	–	–	–	24	312	6	200	4
EWS242GQ, EWS242GQ-1	600	12	–	–	–	48	624	12	600	12
EWS302GQ	1000	20	–	–	–	72	1040	20	800	16

Greensand Plus™ is a trademark of Inversand Company.

EcoWater Systems LLC COMMERCIAL SERIES WATER FILTERS – 2” VALVE

BEDDING SEQUENCE OF GRAVEL & MINERALS

NOTE: Be sure distributor assembly is centered in tank before filling.

**NO MEDIA
(GRAVEL ONLY) FILTERS**

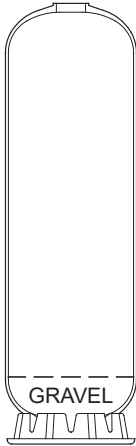

CARBON FILTERS

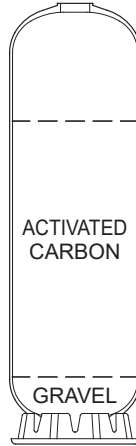

MULTI-MEDIA FILTERS



**GREENSAND PLUS™
FILTERS**



EcoWater Systems LLC COMMERCIAL SERIES – 2” VALVE

Media		
	Part Number	Weight (lbs.)
Resin	0502272	53
Gravel, Quartz	7124415	17
	7124423	50
Gravel, Medium	7127073	50
Anthracite	0993070	52
Garnet	0993090	50
Sand, Filter	0993080	50
Carbon, Activated	7336834	27.5
Greensand Plus™	7331101	44

Accessories	
	Part Number
External No Hard Water Shutoff Kit, 2” Valve, DC	7362225
Piston Plug, 2” Valve	7207750
Grip Ring for Above	7192769

Greensand Plus™ is a trademark of Inversand Company.