



Model WHES20
Model WHES30

How to install, operate and
maintain your Demand
Controlled Water Softener

Do not return water softener to store

If you have questions or concerns when
installing, operating or maintaining your
softener, call our toll free number:

1-866-986-3223

Monday - Friday, 8 am - 9 pm EST



Installation and Operation Manual

Table of Contents

Water Softener Safety	3
Before You Start	3
Inspect Shipment	4
Water Softener Dimensions	5
Water Conditioning Information	6
Water Conditioning	6
How A Water Softener Works	6
Softening Cycle	6
Regeneration Cycle	6
Installation Requirements	8
Tools and Parts Needed	8
Location Requirements	9
Air Gap Requirements	9
Valve Drain Requirements	10
Planning Installation	11
Inlet – Outlet Plumbing Options	11
Installation	12
Turn Off Water Supply	12
Install Brine Tank Overflow Elbow	12
Move the Water Softener into Place	13
Assemble Inlet and Outlet Plumbing	14
Connect Inlet and Outlet Plumbing	14
Install Valve Drain Hose	15
Install Salt Storage Tank Overflow Hose	15
Test for Leaks	16
Add Water and Salt to the Salt Storage Tank	16
Sanitize the Softener/Sanitize After Service	16
Plug in Water Softener	16
Program the Water Softener – Model WHES20	17
Set Time of Day	17
Set Water Hardness Number	18
Set Recharge (Regeneration) Time	18
Start a Recharge	18
Program the Water Softener – Model WHES30	19
Set Time of Day	19
Set Water Hardness Number	20
Set Recharge (Regeneration) Time	20
Start a Recharge	20
Customizing Features / Options–Model WHES20	21
Recharge	21
Recharge Tonight	21
“Power–Outage Memory”	21
Salt Efficiency	22
Customizing Features / Options–Model WHES30	23
Recharge	23
Recharge Scheduled / Tonight	23
Set Salt Level	23
Electronic Control / “Power–Outage Memory”	24
Water Flow Indicator	24
Salt Efficiency	24
Clean / Clear Water Iron Removal	25
Clean Feature Minutes	25
Maximum Days Between Regenerations	26
12 or 24 Hour Clock	26
Routine Maintenance	27
Refilling With Salt	27
Breaking A Salt Bridge	27
Cleaning the Nozzle and Venturi	28

Troubleshooting Guide	29
Automatic Electronic Diagnostics	30
Manual Advance Diagnostics – Model WHES20	30
Manual Advance Regeneration Check – Model WHES20	31
Manual Advance Diagnostics – Model WHES30	32
Manual Advance Regeneration Check – Model WHES30	33
Wiring Schematic	35
Warranty	35
Softener Components	36

Water Softener Safety

Your safety and the safety of others are very important.

We have provided many important safety messages in this manual and on your appliance. Always read and obey all safety messages.



This is the safety alert symbol.

This symbol alerts you to potential hazards that can kill or hurt you and others.

All safety messages will follow the safety alert symbol and either the word “DANGER” or “WARNING.” These words mean:

! DANGER

You can be killed or seriously injured if you don't immediately follow instructions.

! WARNING

You can be killed or seriously injured if you don't follow instructions.

All safety messages will tell you what the potential hazard is, tell you how to reduce the chance of injury, and tell you what can happen if the instructions are not followed.

For installations in the Commonwealth of Massachusetts:
Installation by a licensed plumber is required. Plumbing code 248-CMR of the Commonwealth of Massachusetts must be used for installation.

For installations in the state of California:
You must turn the Salt Efficiency Feature setting to ON. This may initiate more frequent re-charges, however, it will operate at 4,000 grains per pound of salt or higher. To turn on the Salt Efficiency Feature, follow the instructions in the “Salt Efficiency” section of this manual.

Before You Start

See “Location Requirements” section before installing water softener.

Follow the installation instructions carefully. (Failure to install the water softener properly voids the warranty.)

Before you begin installation, read this entire manual. Then, obtain all the materials and tools you will need to make the installation.

Check local plumbing and electrical codes.

Use only lead-free solder and flux for all sweat-solder connections, as required by federal codes.

Use care when handling the water softener. Do not turn upside down, drop, or set on sharp protrusions.

Avoid installing in direct sunlight. Excessive sun heat may cause distortion or other damage to non-metallic parts.

The water softener requires a minimum water flow of 3 gallons per minute at the inlet. Maximum allowable inlet water pressure is 125 psi. If daytime pressure is over 80 psi, nighttime pressure may exceed the maximum. Use a pressure reducing valve if necessary. (Adding a pressure reducing valve may reduce the flow.) If your home is equipped with a back flow preventer, an expansion tank must be installed in accordance with local codes and laws.

The water softener works on 24 volt-60 hz electrical power only, supplied by a direct plug-in transformer (included). Be sure to use the included transformer and plug it into a nominal 120V, 60 cycle household outlet that is properly protected by an overcurrent device such as a circuit breaker or fuse. If transformer is replaced, use only the authorized service, Class II, 24V 10VA transformer.

This system is not intended to be used for treating water that is microbiologically unsafe or of unknown quality without adequate disinfection before or after the system.

Inspect Shipment

The parts required to assemble and install the water softener are included with the water softener.

Copper tubes and ground clamp

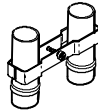

Single valve bypass

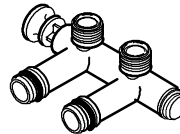

20 ft. green drain hose

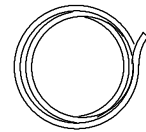

Hose adaptor



Hose clamps



Installation nuts



Clips



Washers



Grommet



Water hardness test strip



Thoroughly check the water softener for possible shipping damage and parts loss. Also inspect and note any damage to the shipping carton.

Remove and discard (or recycle) all packing materials. To avoid loss of small parts, we suggest you keep the small parts in the parts bag until you are ready to use them.

Do not return the water softener to store.

If you have any questions, or there are missing parts or damage, please call 1-866-986-3223, Monday – Friday, 8 am – 9 pm EST.

Before you call please have your model number, date of purchase, water conditions and number of people living in your home.

For future reference, enter the following information.

Model No. ❶ ❷ _____ Serial No. ❶ ❷ _____

Code ❶ _____ Installation date _____

*Water hardness _____ gpg **Iron content _____ ppm

❶ on registration decal (located under salt hole cover) ❷ on shipping carton

* A hardness test strip is provided with your water softener.

** Kits are available at retail hardware stores for testing water hardness and iron content. Some retail stores will also test your water for a fee.

Water Softener Dimensions

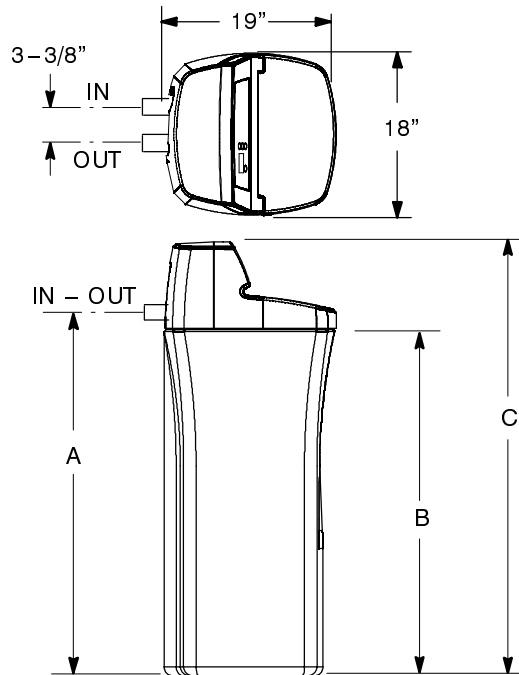

MODEL	NOMINAL RESIN TANK SIZE	A	B	C
WHES20	8" DIA. X 35"	36-1/2"	35"	43-5/16"
WHES30	9" DIA. X 35"	36-1/2"	35"	43-5/16"

How a Water Softener Works

Softening Cycle

When the water softener is providing soft water, it is called “service” or the “softening cycle”. During this cycle, hard water flows from the main water pipe in the household into the water softener. Inside the resin tank is a bed made up of thousands of tiny, plastic resin beads. As hard water passes through the bed, each bead attracts and holds the hardness minerals. Water without the hardness minerals (soft water) flows from the water softener to the rest of the house.

Regeneration Cycle

Eventually the beads become coated with calcium or magnesium ions. At this point, the water softener needs to replenish the beads with sodium ions. This process is called “regeneration”.

Regeneration occurs when the resin beads are washed with a strong salt water solution. The sodium forces the calcium and magnesium ions to be released where they are then discharged as waste during the regeneration cycle. The beads are then ready to once again to collect the hardness minerals (calcium and magnesium) from the water. Regeneration consists of five cycles; brine fill, brining, brine rinse, backwash and fast rinse. The total time of the regeneration cycle is approximately two hours.

Water Conditioning Information

Water Conditioning

Water conditioning is the treatment of four general conditions. These are:

Hardness

Iron

Acidity

Sediments

1. Hardness is a term to describe the presence of calcium and magnesium minerals in water. A chemical analysis accurately measures the amount of minerals in grain weight. For example, one gallon of water with 5 grains per gallon (gpg) hardness has dissolved minerals, that if solidified, about equals the size of one ordinary aspirin tablet. One gallon of water, 25 gpg hard, has a mineral content equal in size to 5 aspirin tablets. Water hardness varies greatly across the country. It generally contains from 3 to 100 gpg.

Hardness minerals combine with soap to make a soap curd. The curd greatly reduces the cleaning action of soap. Precipitated hardness minerals form a crust on cooking utensils, appliances, and plumbing fixtures. Even the tastes of foods are affected. A water softener removes the hardness minerals to eliminate these effects, and others.

IMPORTANT: Water softeners using sodium chloride (salt) for regeneration add sodium to the water. Persons on sodium restricted diets should consider the added sodium as part of their overall intake. Water softeners using potassium chloride (salt) for regeneration add potassium to the water. Persons on potassium restricted diets should consider the added potassium as part of their overall intake.

Factor into your diet the amount of sodium or potassium shown below, based on your water hardness and consumption.

Sodium Added to Water from Cation Exchange Softening		
Initial Water Hardness	Sodium added by Cation Exchange Softening of Water*	Potassium added by Cation Exchange Softening of Water**
Grains per Gallon	Milligrams Na+/qt.	Milligrams K+/qt.
1	7.5	12.75
5	37	62.9
6	44	74.8
7	52	88.4
8	60	102
9	68	115.6
10	75	127.5
15	112	190.4
20	150	255
30	225	382.5
40	300	510

*If your water supply is 15 grains hard and you drank 3 quarts of softened water you would consume 335 milligrams of sodium. That is equivalent to eating 2-1/2 slices of white bread.

**One large banana, about 9 inches in length, has approximately 600 milligrams of potassium.

2. Iron in water can cause stains on clothing and plumbing fixtures. It can negatively affect the taste of food, drinking water, and other beverages. Iron in water is measured in parts per million (ppm). The total* ppm of iron, and type or types*, is determined by chemical analysis. Four different types of iron in water are:

Ferrous (clear water),

Ferric (red water),

Bacterial and organically bound iron,

Colloidal and inorganically bound iron (ferrous or ferric).

*Water may contain one or more of the four types of iron and any combination of these. Total iron is the sum of the contents.

Ferrous (clear water) iron is soluble and dissolves in water. This water softener will remove moderate amounts of this type of iron (see specifications). Ferrous (clear water) iron is usually detected by taking a sample of water in a clear bottle or glass. Immediately after taking, the sample is clear. As the water sample stands, it gradually clouds and turns slightly yellow or brown as air oxidizes the iron. This usually occurs in 15 to 30 minutes.

When using the softener to remove Ferrous (clear water) iron, add 5 grains to the hardness setting for every 1 ppm of Ferrous (clear water) iron.

Ferric (red water), and bacterial and organically bound irons are insoluble. This water softener will not remove ferric or bacterial iron. This iron is visible immediately when drawn from a faucet because it has oxidized before reaching the home. It appears as small cloudy yellow, orange, or reddish suspended particles. After the water stands for a period of time, the particles settle to the bottom of the container. Generally these irons are removed from water by filtration. Chlorination is also recommended for bacterial iron.

Colloidal and inorganically bound iron is of ferric or ferrous form that will not filter or exchange out of water. This water softener will not remove colloidal iron. In some instances, treatment may improve colloidal iron water. Colloidal iron water usually has a yellow appearance when drawn. After standing for several hours, the color persists and the iron does not settle, but remains suspended in the water.

3. Acidity or acid water is caused by carbon dioxide and hydrogen sulfide. This water softener will not improve an acid condition in water. Acid water can be corrosive to plumbing, plumbing fixtures, water heaters, and other water using appliances. It can also damage and cause premature failure of seals, diaphragms, etc., in water handling equipment.

A chemical analysis is needed to measure the degree of acidity in water. This is called the pH of water. Water testing below 6.9 pH is acidic. The lower the pH reading, the greater the acidity. A neutralizer filter or a chemical feed pump are usually recommended to treat acid water.

4. Sediment is fine, foreign material particles suspended in water. This water softener will not remove sediment. This material is most often clay or silt. Extreme amounts of sediment may give the water a cloudy appearance. A sediment filter installed ahead of the water softener normally corrects this situation.

Installation Requirements

Tools and Parts Needed

Assemble the required tools before starting installation. Read and follow the instructions provided with any tools listed here.

- Screwdriver
- Pliers
- Tape Measure

If using Soldered Copper Pipe

- Tubing cutter
- Propane torch
- Misc. copper pipe fittings
- Lead-free solder and flux
- Emery cloth, sandpaper or steel wool

If using Threaded Pipe

- Pipe cutter or hacksaw
- Threading tool
- Pipe joint compound
- Misc. threaded pipe fittings

If using CPVC Plastic

- Pipe cutter
- Hacksaw
- Adjustable wrench
- Solvent cement
- Primer
- Misc. CPVC pipe fittings

If using Other

- Other pipe and fittings suitable for potable water supply as required by piping system manufacturer and local codes and/or ordinances.

Location Requirements

Consider all of the following when selecting an installation location for the water softener.

- Do not locate the water softener where freezing temperatures occur. Do not attempt to treat water over 120°F. Freezing, or hot water damage voids the warranty.
- To condition all water in the home, install the water softener close to the water supply inlet, and before all other plumbing connections, except outside water pipes. Outside faucets should remain on hard water to avoid wasting conditioned water and salt.
- A nearby drain is needed to carry away regeneration discharge (drain) water. Use a floor drain, laundry tub, sump, standpipe, or other options (check your local codes). See “Air Gap Requirements” and “Valve Drain Requirements” sections.
- The water softener works on 24 volt-60 hz electrical power only, supplied by a direct plug-in transformer (included). Provide an electrical outlet in accordance with NEC and local codes.
- Always install the water softener between the water heater and water inlet. Any other installed water conditioning equipment should be installed between the water softener and the water inlet (see Figure 1 below).

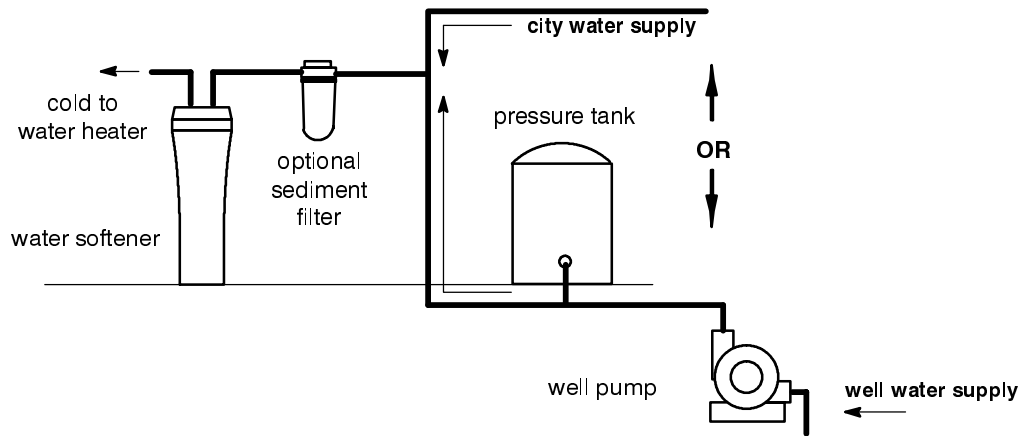

Figure 1

Air Gap Requirements

A drain is needed for regeneration discharge water. A floor drain, close to the water softener, is preferred. A laundry tub, standpipe, etc., are other drain options. Secure valve drain hose in place.

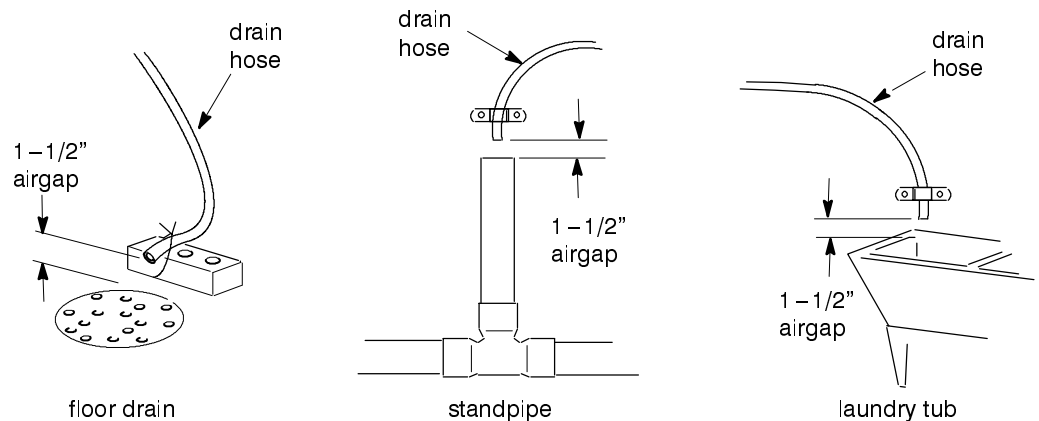

Figure 2

Valve Drain Requirements

Use the flexible green drain hose, that is included, measure and cut to the length needed. Flexible drain hose is not allowed in all localities (check your plumbing codes). If local codes do not allow use of a flexible drain hose, a rigid valve drain run must be used. Buy a compression fitting (1/4 NPT x 1/2 in. minimum tube) and 1/2" tubing from your local hardware store. Then plumb a rigid drain as needed (see Figure 3).

NOTE: Avoid long drain hose runs, or elevating the hose more than 8' above the floor. Make the water softener valve drain as short and direct as possible.

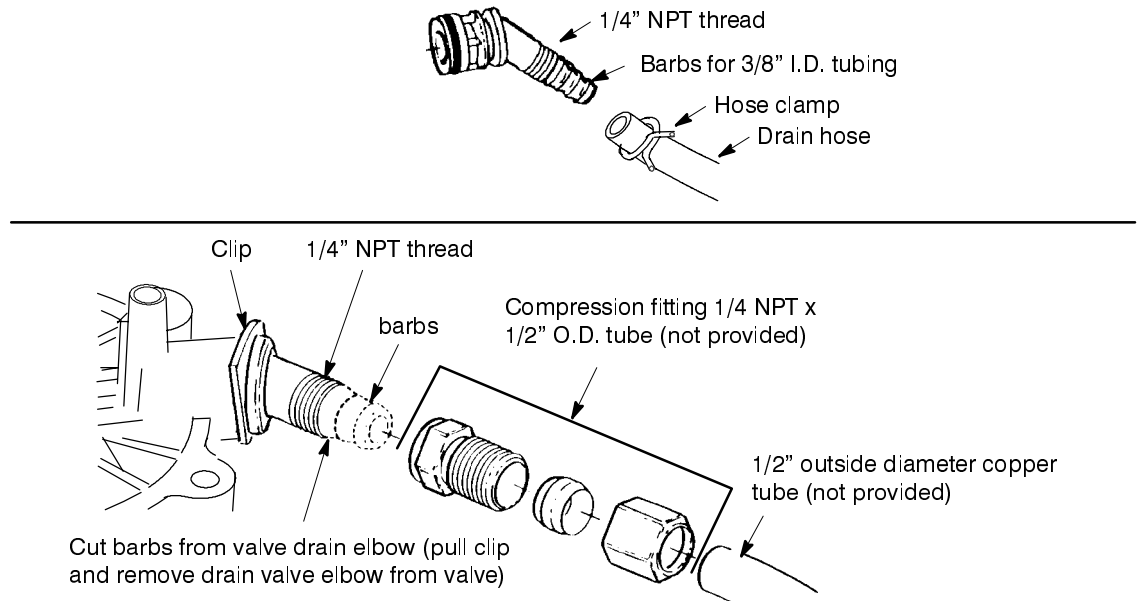

Figure 3

Plan the Installation

Inlet – Outlet Plumbing Options

Always install either a single bypass valve (provided) or, if desired, parts for a 3 valve bypass system (not included) can be purchased and assembled, as shown in Figure 4. Bypass valves allow you to turn off water to the softener for maintenance if needed, but still have water in house pipes.

NOTE: If you choose to install a 3 valve bypass, you will still need to use the included single valve bypass to connect to the softener.

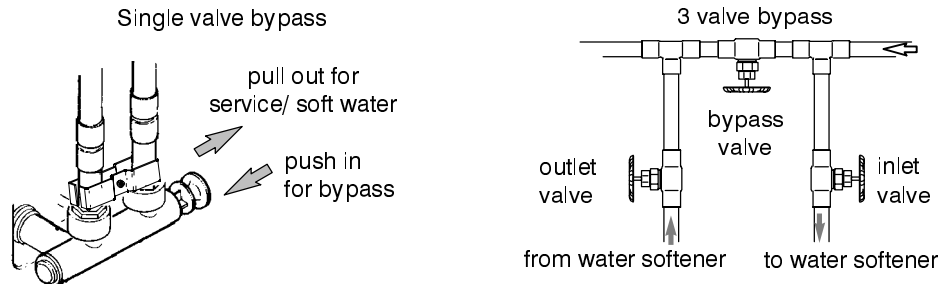

Figure 4

- Pipe and fittings must be 3/4" minimum.

Use either:

- Copper pipe
- CPVC plastic pipe
- Threaded pipe
- Other pipe approved for use with potable water

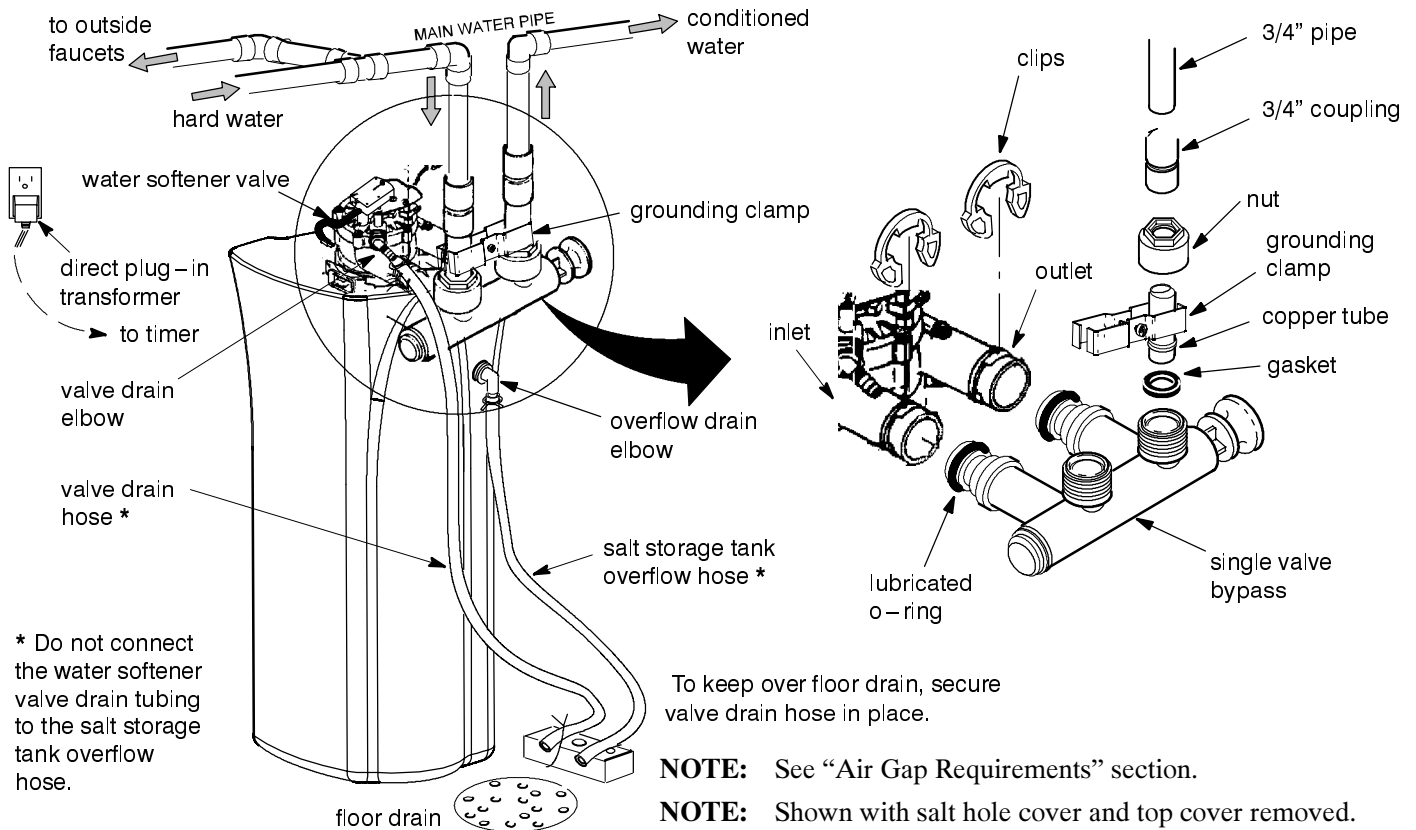

Figure 5 (typical installation)

Installation

Turn Off Water Supply

1. Close the main water supply valve, near the well pump or water meter.
2. Open all faucets to drain all water from the house pipes.

NOTE: Be sure not to drain water from the water heater, as damage to the water heater elements could result.

Install the Brine Tank Overflow Elbow

Install the brine tank overflow grommet and elbow in the 13/16" diameter hole in the back of the salt storage tank sidewall.

NOTE: The salt storage tank drain elbow accepts either 1/2" or 3/8" I. D. hose.

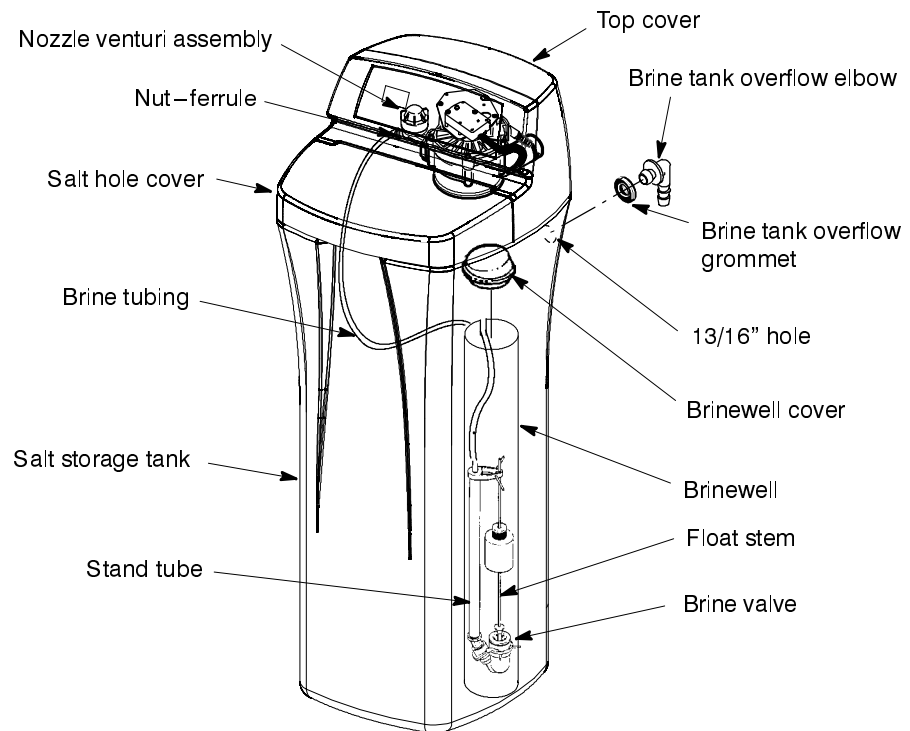

Figure 6

Move the Water Softener into Place

⚠ WARNING

Excessive Weight Hazard

Use two or more people to move and install water softener.

Use two or more people to move and lift salt bags.

Failure to do so can result in back or other injury.

1. Move the water softener into installation position. Set it on a level surface. If needed, place the water softener on a section of plywood, a minimum of 3/4" thick. Then, shim under the plywood to level the water softener, see Figure 7.

IMPORTANT: Do not place shims directly under the salt storage tank. The weight of the tank, when full of water and salt, may cause the tank to fracture at the shim.

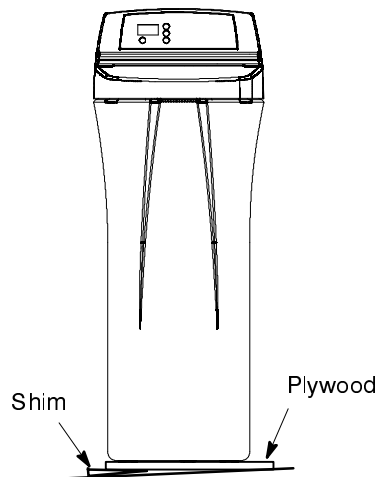
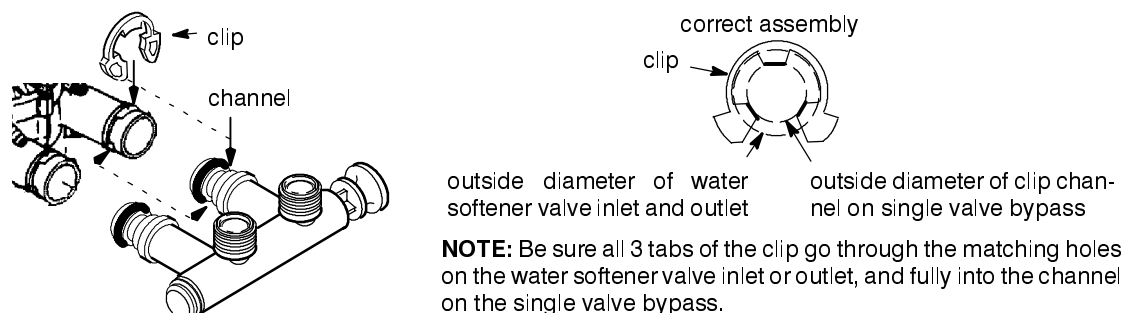

Figure 7 (if needed for leveling)

2. Visually check and remove any debris from the water softener valve inlet and outlet ports.
3. Remove and discard the yellow plug and make sure the turbine assembly spins freely in the "out" port of the valve.
4. If not already done, put a light coating of silicone grease or petroleum jelly on the bypass valve o-rings.
5. Push the bypass valve into the softener valve as far as it will go. Snap the two large holding clips into place, from the top down as shown in Figure 8.

IMPORTANT: Be sure the clips snap firmly into place so the single valve bypass will not pull out.



NOTE: Be sure all 3 tabs of the clip go through the matching holes on the water softener valve inlet or outlet, and fully into the channel on the single valve bypass.

Figure 8

Assemble Inlet and Outlet Plumbing

Measure, cut, and loosely assemble pipe and fittings from the main water pipe to the inlet and outlet ports of the water softener valve. Be sure to keep fittings fully together, and pipes squared and straight. Be sure hard water supply pipe goes to the water softener valve inlet side.

NOTE: Inlet and outlet are marked on the valve. Trace the water flow direction to be sure.

IMPORTANT: Be sure to fit, align and support all plumbing to prevent putting stress on the softener valve inlet and outlet. Undue stress from misaligned or unsupported plumbing may cause damage to the valve.

Connect Inlet and Outlet Plumbing

Complete the inlet and outlet plumbing for the type of pipe as shown below.

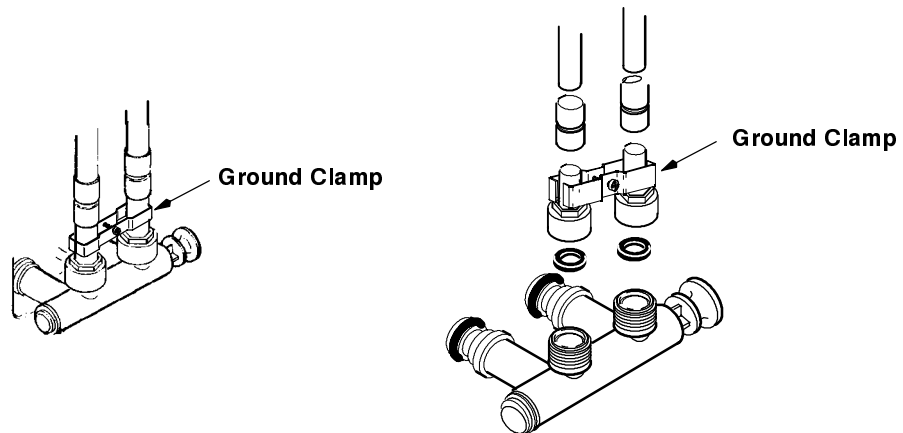
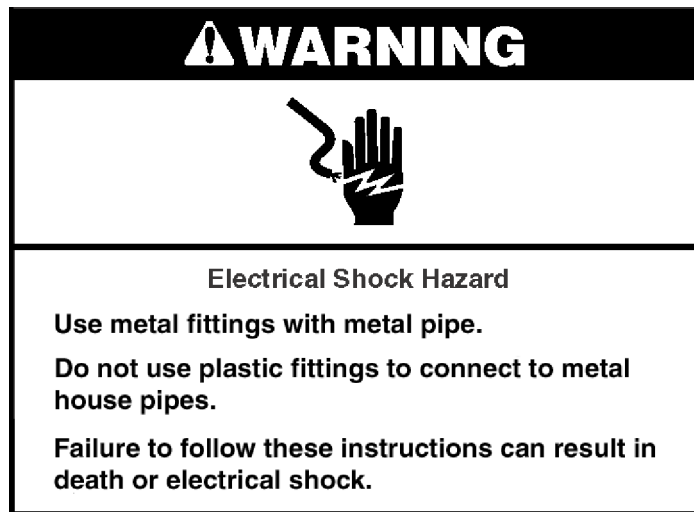

Figure 9

Soldered copper

1. Thoroughly clean and apply solder flux to all joints.
2. Make all solder connections.

NOTE: Do not solder with installation tubes attached to single valve bypass. Soldering heat will damage the valve.

IMPORTANT: When installing the copper tubes and ground clamp assembly to the single valve bypass, the ground clamp must be secured in place. If necessary tighten the screw.

Threaded pipe

1. Apply pipe joint compound or Teflon[®] tape to all male pipe threads.
2. Tighten all threaded joints and make all solder connections.

NOTE: Do not solder with installation tubes attached to single valve bypass. Soldering heat will damage the valve.

IMPORTANT: When installing the copper tubes and ground clamp assembly to the single valve bypass, the ground clamp must be secured in place. If necessary tighten the screw.

CPVC plastic pipe

1. Clean, prime and cement all joints, following the manufacturer's instructions supplied with the plastic pipe and fittings.

NOTE: Do not solder with installation tubes attached to single valve bypass. Soldering heat will damage the valve.

IMPORTANT: When installing the copper tubes and ground clamp assembly to the single valve bypass, the ground clamp must be secured in place. If necessary tighten the screw.

Other

1. Follow the piping system manufacturer's instructions when using other pipe approved for potable water.

IMPORTANT: When installing the copper tubes and ground clamp assembly to the single valve bypass, the ground clamp must be secured in place. If necessary tighten the screw.

Install Valve Drain Hose

1. Measure, cut to needed length and connect the 3/8" green drain line (provided) to the water softener valve drain fitting. Use a hose clamp to hold the hose in place.

NOTE: If codes require a rigid drain line see "Valve Drain requirements" section.

2. Run the green drain hose or copper tubing to the floor drain. Secure green drain hose. This will prevent "whipping" during regenerations. See "Air Gap Requirements" section.

Install Salt Storage Tank Overflow Hose

1. Measure, cut to needed length and connect the 3/8" green drain line (provided) to the salt storage tank overflow elbow and secure in place with a hose clamp.
2. Run the hose to the floor drain, or other suitable drain point no higher than the drain fitting on the salt storage tank. (This is a gravity drain.) If the tank overfills with water, the excess water flows to the drain point. Cut the green drain line to the desired length and route neatly out of the way.

IMPORTANT: For proper operation of the water softener, do not connect the water softener valve drain tubing to the salt storage tank overflow hose.

Test for Leaks

To prevent air pressure in the water softener and plumbing system, do the following steps in order.

1. Fully open two or more softened cold water faucets close by the water softener, located downstream from the water softener.
2. Place the single valve bypass valve or 3 valve bypass in “bypass” position. See “Plan The Installation” section.
3. Fully open the main water supply valve. Run water until there is a steady flow from the opened faucets, with no air bubbles.
4. Place bypass valve(s) in “service” or soft water position as follows:
 - Single valve bypass: Slowly move the valve stem toward “service”, pausing several times to allow the water softener to fill with water.
 - 3 valve bypass: Fully close the bypass valve and open the outlet valve. Slowly open the inlet valve, pausing several times to allow the water softener to fill with water.
5. After about three minutes, open a hot water faucet until there is a steady flow and there are no air bubbles, then close.
6. Close all cold water faucets and check for leaks at the plumbing connections that you made.

Add Water and Salt to the Salt Storage Tank

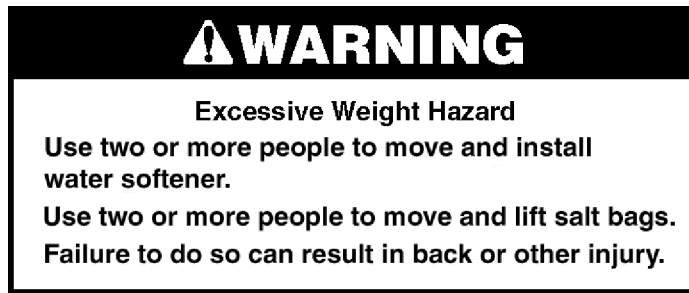

1. Using a container, add about three gallons of clean water into the salt storage tank.
2. Fill the salt storage tank with salt. Use nugget, pellet or coarse solar salts with less than 1% impurities.

NOTE: See “Routine Maintenance Section” for additional information on salt.

Sanitize the Softener/Sanitize After Service

1. Open salt hole cover and remove the brinewell cover and pour about 1-1/2 oz. (2 to 3 tablespoons) of household bleach into the softener brinewell. Replace the brinewell cover.
2. Make sure the bypass valve(s) is in the service (open) position.
3. Sanitize procedure will be completed when first cycle is run and sanitizing solution is flushed from the water softener.

Plug in Water Softener

During installation, the water softener wiring may be moved or jostled from place. Check to be sure all leadwire connectors are secure on the back of the electronic board and be sure all wiring is away from the valve gear and motor area, which rotates during regenerations.

1. Plug the water softener into an electrical outlet that is not controlled by a switch.

NOTE: The water heater is filled with hard water and, as hot water is used, it refills with conditioned water. In a few days, the hot water will be fully conditioned. To have fully conditioned hot water immediately, wait until the initial recharge is over. Then, drain the water heater (following instructions for water heater) until water runs cold.

Program the Water Softener – Model WHES20

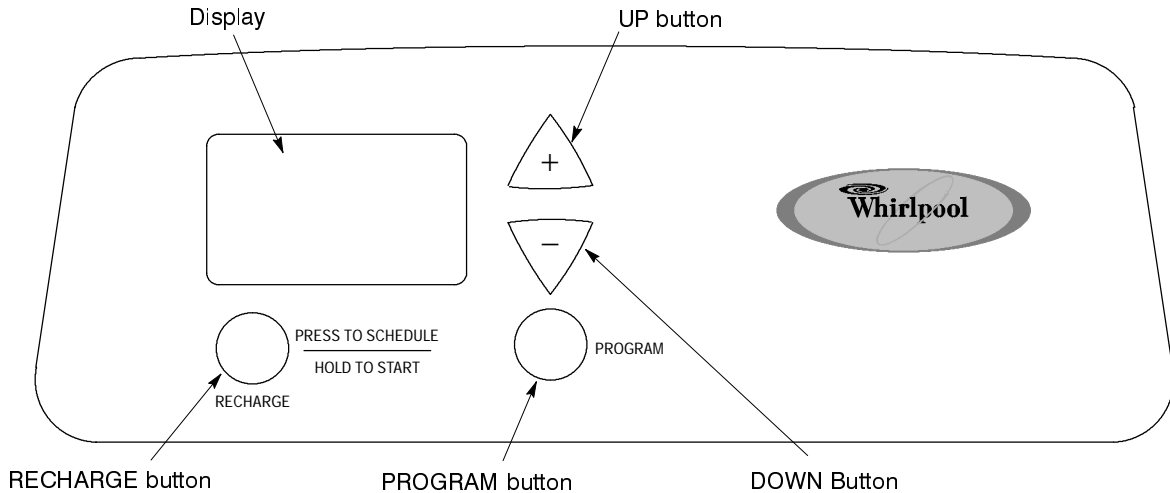





Figure 10



If you have questions about installation, programming, operating and routine maintenance...
call 1-866-986-3223, Monday - Friday, 8 am to 9 pm, EST.

When the transformer is plugged into the electrical outlet, a model code and a test number (example: s3.0), begin to flash in the faceplate display. Then, 12:00 PM and the words “PRESENT TIME” begin to flash.

NOTE: If SR - - shows in the display, press the UP  or DOWN  button until SR17 shows in the display. Then, press the  PROGRAM button to set, and change to the flashing “PRESENT TIME” display.

Set Time of Day

If the words “PRESENT TIME” do not show in the display, press the  PROGRAM button until they do.

1. Press the  Up or  Down buttons to set the present time. Up moves the display ahead; down sets the time back.

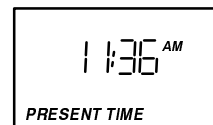
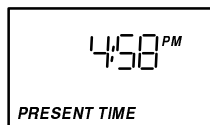

Be sure AM or PM is correct.

NOTE: Press buttons and quickly release to slowly advance the display. Hold the buttons down for fast advance. This procedure applies for all following settings.

Set Water Hardness Number

1. Press the  PROGRAM button once again to display a flashing 25 and the word “HARDNESS”.



2. Press the  Up or  Down buttons to set your water hardness number.



NOTE: Be sure to enter the grains per gallon (gpg) hardness of your water supply on page 5, for future reference. If your water supply contains iron, compensate for it by adding to the water hardness number. For example, assume your water is 20 gpg hard and contains 2 ppm iron. Add 5 to the hardness number for each 1 ppm of iron. In this example, you would use 30 for your hardness number.

$$\begin{array}{r} 20 \text{ gpg hardness} \\ 2 \text{ ppm iron} \times 5 = 10 \\ \text{(times)} \quad \quad \quad +10 \\ \hline 30 \text{ HARDNESS NUMBER} \end{array}$$

Set Recharge (Regeneration) Time

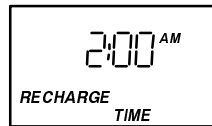
1. Press the  PROGRAM button once again to display a flashing 2:00AM and the words “RECHARGE TIME”. This is a good time for the recharge to start in most households because water is not in use.



If you want to change the recharge start time, press the  Up or  Down buttons until the desired starting time shows.

2. Press the  PROGRAM button once again to return to normal operating display.

Start a Recharge

Press the  RECHARGE button and hold for three seconds until the word “Recharge” begins to flash in the timer display, starting a recharge. This recharge draws the sanitizing bleach into and through the water softener. Any air remaining in the water softener is purged to the drain.

If you have questions about installation, electronic programming, operating and routine maintenance...

call 1-866-986-3223, Monday - Friday, 8 am to 9 pm, EST.

Program the Water Softener – Model WHES30

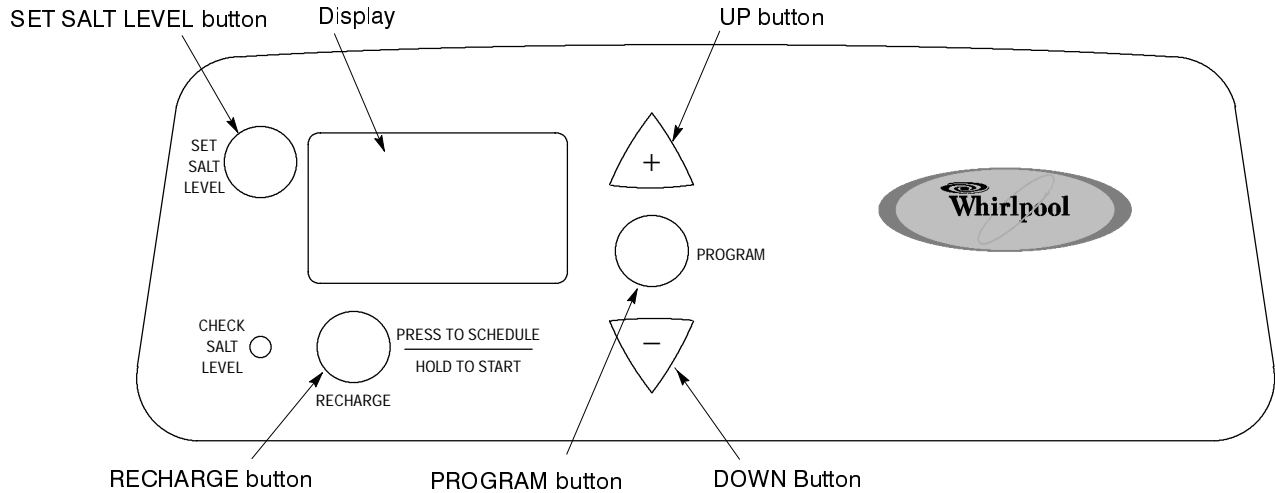





Figure 11



If you have questions about installation, programming, operating and routine maintenance...
call 1-866-986-3223, Monday - Friday, 8 am to 9 pm, EST.

When the transformer is plugged into the electrical outlet, a model code and a test number (example: s3.0), begin to flash in the faceplate display. Then, 12:00 PM and the words “CURRENT TIME” begin to flash.

NOTE: If - - - shows in the display, press the UP  or DOWN  button until LE30 shows in the display. Then, press the  PROGRAM button to set, and change to the flashing CURRENT TIME display.

Set Time of Day

If the words “CURRENT TIME” do not show in the display, press the  PROGRAM button until they do.

1. Press the  Up or  Down buttons to set the present time. Up moves the display ahead; down sets the time back.

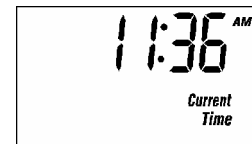
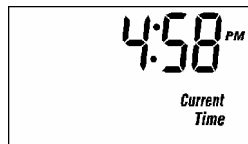

Be sure AM or PM is correct.

NOTE: Press buttons and quickly release to slowly advance the display. Hold for fast advance. This procedure applies for all following settings.

Customizing Features/Options – Model WHES20

Recharge

Recharge button is used to initiate an immediate recharge.

- Press and hold the  RECHARGE button until the words “RECHARGE NOW” flashes in the display, and the softener enters the fill cycle of regeneration right away. “RECHARGE NOW” will flash during the regeneration. When over, full water conditioning capacity is restored.



RECHARGE NOW Initiated

NOTE: Avoid using hot water while the conditioner is regenerating, because the water heater will refill with bypass hard water.

Recharge Tonight

If you do not want to start an immediate recharge, but would like an extra recharge at the next preset recharge time, do the following to schedule a recharge.

- Press and release (do not hold) the  RECHARGE button. The words “RECHARGE TONIGHT” flashes in the display, and the softener will recharge at the next recharge time. “RECHARGE NOW” will flash during the regeneration. When over, full water conditioning capacity is restored.



RECHARGE TONIGHT Initiated

“Power–Outage Memory”

If electrical power to the water softener is lost, “memory” built into the timer circuitry will keep all settings for up to eight hours. While the power is out, the display is blank and the water softener will not regenerate. When electrical power is restored, the following will occur.

1. You have to reset the present time only if the display is flashing. The HARDNESS and RECHARGE TIME never require resetting unless a change is desired. Even if the clock is incorrect after a long power outage, the softener works as it should to keep your water soft. However, regenerations may occur at the wrong time of day until you reset the clock to the correct time of day.

NOTE: If the water softener was regenerating when power was lost, it will now finish the cycle.

Salt Efficiency

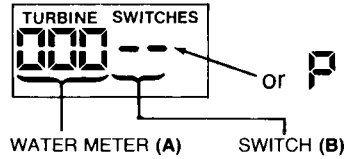

When this feature is ON, the water softener will operate at salt efficiencies of 4000 grains of hardness per pound of salt or higher. (May recharge more often using smaller salt dosage and less water). The softener is shipped in the OFF setting.

1. Press and hold the  PROGRAM button until the following screen is displayed.

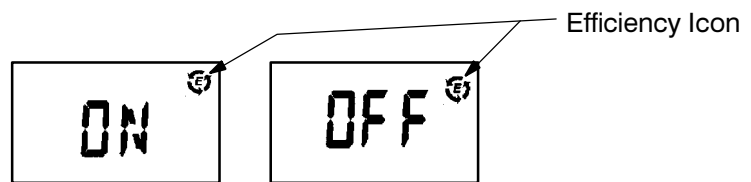

Once in this display, press the  PROGRAM button and one of the following two displays is shown.



2. Press the  Up or  Down buttons to set On or Off. When set to On, the efficiency icon will be displayed in the upper right hand corner of the normal run display.
3. Press the  PROGRAM button once again, to return to normal run display.

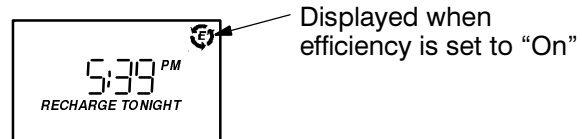

If you have questions about installation, programming, operating and routine maintenance...

call 1-866-986-3223, Monday - Friday, 8 am to 9 pm, EST.

Customizing Features/Options – Model WHES30

Recharge

Recharge button is used to initiate an immediate recharge.

- Press and hold the  RECHARGE button until the words “RECHARGE”, “SERVICE” and “FILL” flash in the display, and the softener enters the fill cycle of regeneration right away. The word “RECHARGE” will flash during the regeneration. When over, full water conditioning capacity is restored.

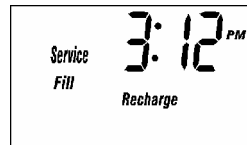

RECHARGE NOW Initiated

NOTE: Avoid using hot water while the conditioner is regenerating, because the water heater will refill with bypass hard water.

Recharge Scheduled

If you do not want to start an immediate recharge, but would like an extra recharge at the next preset recharge time, do the following to schedule a recharge.

- Press and release (do not hold) the  RECHARGE button. The words “RECHARGE SCHEDULED” flashes in the display, and the softener will recharge at the next recharge time. The word “RECHARGE” will flash during the regeneration. When over, full water conditioning capacity is restored.

Set Salt Level

The water softener has a salt monitor indicator light to remind you to refill the storage tank with salt.

- To set this monitor system, lift the salt hole cover and level the salt in the storage tank. The salt level decal, on the brinewell inside the tank, has numbers from 0 to 8. Observe the number the leveled salt is at, or closest to. Now, press the  SET SALT LEVEL button until black ovals correspond to the salt level number. At level 2 or below, the indicator LED will flash “Check Salt Level”.

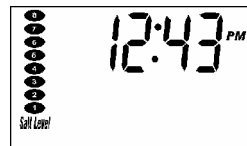

- If you want to turn the salt monitor off, press the  SET SALT LEVEL button until “SALT LEVEL OFF” shows in display.

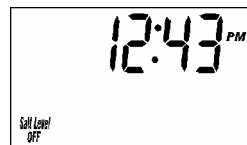

“Power–Outage Memory”

If electrical power to the water softener is lost, “memory” built into the timer circuitry will keep all settings for up to eight hours. While the power is out, the display is blank and the water softener will not regenerate. When electrical power is restored, the following will occur.

1. You have to reset the present time only if the display is flashing. The **HARDNESS** and **RECHARGE TIME** never require resetting unless a change is desired. Even if the clock is incorrect after a long power outage, the softener works as it should to keep your water soft. However, regenerations may occur at the wrong time of day until you reset the clock to the correct time of day.

NOTE: If the water softener was regenerating when power was lost, it will now finish the cycle.

Water Flow Indicator

Whenever the softener has water flowing from the outlet port, the display will show water droplets scrolling down the right hand side of the screen. The faster the water flow, the faster the droplets will flash.

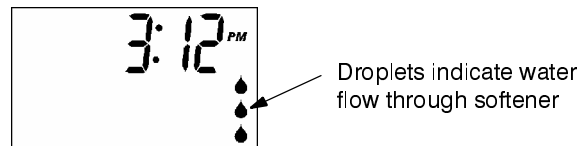

Salt Efficiency

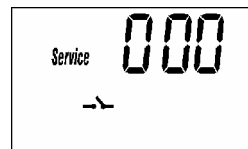

When this feature is ON, the water softener will operate at salt efficiencies of 4000 grains of hardness per pound of salt or higher. (May recharge more often using smaller salt dosage and less water). The softener is shipped in the OFF setting.

1. Press and hold the  PROGRAM button until the following screen is displayed.

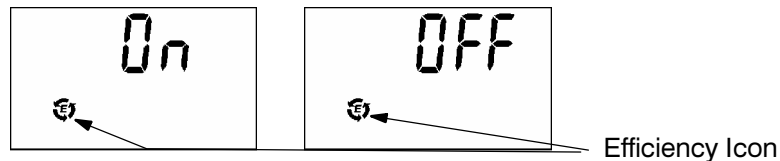

Once in this display, press the  PROGRAM button and one of the following two displays is shown.



2. Press the  Up or  Down buttons to set On or Off. When set to On, the efficiency icon will be displayed in the lower left hand corner of the normal run display.

Clean / Clear Water Iron Removal

This feature is beneficial on water supplies containing iron and/or high amounts of sediments (sand, silt, dirt, etc.). When set to “ON”, an additional backwash and fast rinse cycle will occur first, preceding the normal regeneration sequence. This provides extra cleaning of the resin bed before it is regenerated with the salt brine. To conserve water set this feature “OFF” if your water supply does not contain iron or sediments.

1. Press and hold the  PROGRAM button until the following screen is displayed.



Once in this display, press the  PROGRAM button twice and one of the following two displays is shown. Both displays will show the word “Clean”.

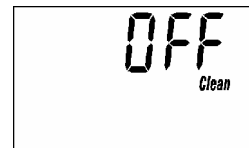
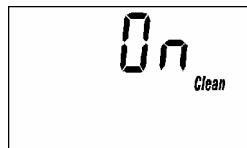

2. Press the  Up or  Down buttons to set On or Off.

Clean Feature Minutes



Adjust the length of the Clean/Clear Water Iron Removal feature, from 1 to 15 minutes in length. To change this cycle time, use the UP button to increase the time, or the DOWN button to shorten the time. If you are using this feature the length of the extra backwash cycle automatically sets to 3 minutes.

1. Press and hold the  PROGRAM button until the following screen is displayed.

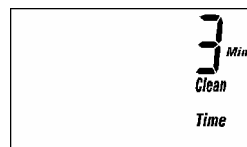

Once in this display, press the  PROGRAM button three times and following display is shown.



2. Press the  Up or  Down buttons to set number of minutes.

Maximum Days Between Regenerations

The water softener automatically controls regeneration frequency. This provides the greatest operating efficiency, and under most conditions, this feature should be left in this mode. However, modify this feature if you want to force a regeneration every set number of days. For example, if your water supply contains iron and you want the softener to regenerate at least once every few days to keep the resin bed clean, set the display as shown below. Setting is available from 1 to 15 days by using the UP and DOWN buttons.

NOTE: The softener will recharge on its own if needed, even if it is before the set number of days.

1. Press and hold the  PROGRAM button until the following screen is displayed.



Once in this display, press the  PROGRAM button four times and following display is shown.

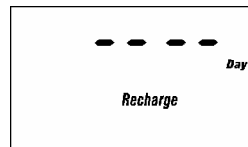



2. Press the  Up or  Down buttons to set number of days.

12 or 24 Hour Clock

All time displays are shown in standard clock time (1 to 12 PM; and 1 to 12 AM) at the 12 hr default setting. If 24 hour clock displays are desired, follow steps below.

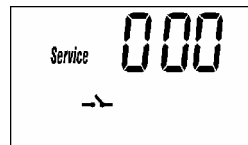
1. Press and hold the  PROGRAM button until the following screen is displayed.



Once in this display, press the  PROGRAM button five times and the following display is shown.

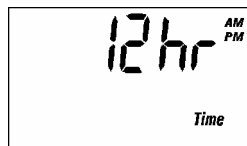

12 Hour Clock Initiated

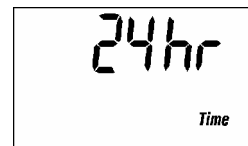

24 Hour Clock Initiated

2. Press the  Up or  Down buttons to set clock.

If you have questions about installation, programming, operating and routine maintenance...

call 1-866-986-3223, Monday - Friday, 8 am to 9 pm, EST.

Routine Maintenance

Refilling With Salt

Lift the salt hole cover and check the salt storage level frequently. If the conditioner uses all the salt before you refill it, you will get hard water. Until you have established a refilling routine, check the salt every two or three weeks. Always refill if less than 1/3 full. Be sure the brinewell cover is on.

NOTE: In humid areas, it is best to keep the salt storage level lower, and to refill more often.

Recommended Salt: Nugget, pellet or coarse solar salts with less than 1% impurities.

Salt Not Recommended: Rock salt, high in impurities, block, granulated, table, ice melting, ice cream making salts, etc., are not recommended.

Breaking A Salt Bridge

NOTE: If you see more than a few inches of water in the bottom of the tank, see “Cleaning the Nozzle and Venturi” section.

Sometimes, a hard crust or salt bridge forms in the brine tank. It is usually caused by high humidity or the wrong kind of salt. When the salt bridges, an empty space forms between the water and the salt. Then, salt will not dissolve in the water to make brine. Without brine, the resin bed does not regenerate and you will have hard water.

If the storage tank is full of salt, it is hard to tell if you have a salt bridge. Salt is loose on top, but the bridge is under it. Take a broom handle, or like tool, hold it next to the water softener, measure the distance from the floor to the rim of the water softener. Then push the broom handle straight down into the salt. If a hard object is felt, it's most likely a salt bridge. Carefully push into the bridge in several places to break it. Do not use any sharp or pointed objects as you may puncture the brine tank.

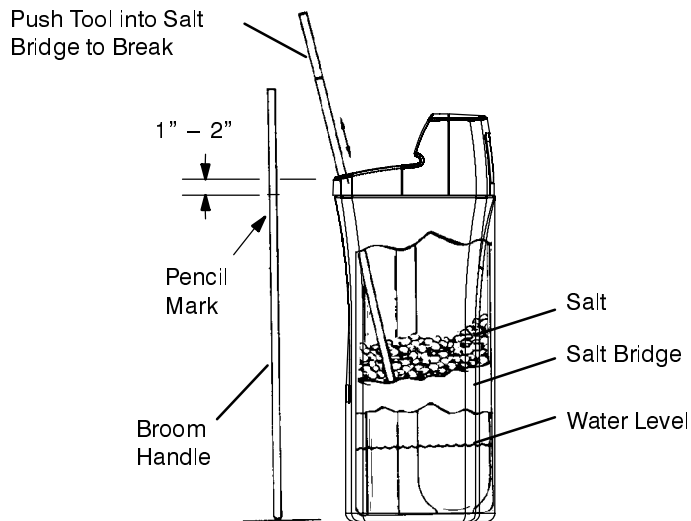

Figure 12

Cleaning the Nozzle and Venturi

A clean nozzle and venturi (see Figure 13) is a must for the conditioner to work properly. This small water softener creates the suction to move brine from the brine tank, into the resin tank. If it should become plugged with sand, silt, dirt, etc., the conditioner will not work, and you will get hard water.

To get to the nozzle and venturi, remove the top cover. Be sure the water softener is in soft water cycle (no water pressure at nozzle and venturi). Then, holding the nozzle and venturi housing with one hand, turn off the cap. Do not lose the o-ring seal. Lift out the screen support and screen. Then, remove the nozzle and venturi. Wash the parts in warm, soapy water and rinse in fresh water. If needed, use a small brush to remove iron or dirt. Do not scratch, misshape, etc., surfaces of the nozzle and venturi. Also, check and clean the gasket and flow plug(s).

Replace all parts in the correct order. Lubricate the o-ring seal with silicone grease and locate in position. Install and tighten the cap, by hand only. Do not overtighten and break the cap or housing.

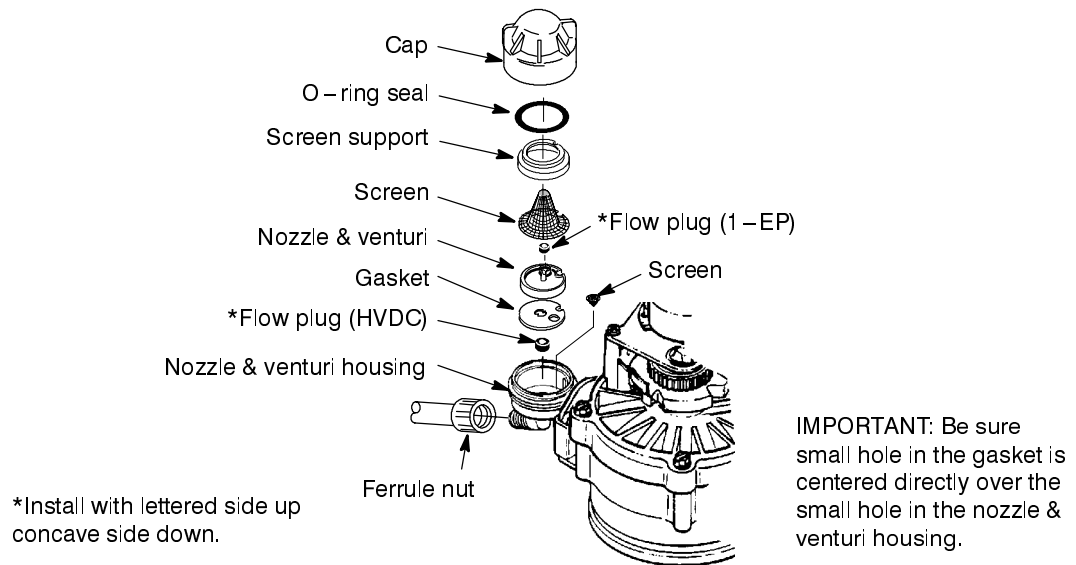

Figure 13

Recharge the softener several times to reduce water level in the tank. This will also assure that the softener is completely recharged and ready to provide softened water again. Once the water level in the tank is about 2" to 3", you may resume normal use. If the water level does not drop after a couple of recharges, do the following:

Remove the brine valve assembly from the brinewell and push float stem down. Place opening of brine valve just under the water and start a recharge. Move the brine valve down with each recharge, until it rests at the bottom of the tank. Add salt, if needed, and return to normal use.

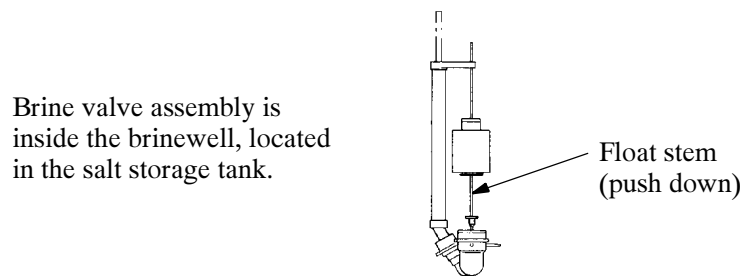

Figure 14

If you have questions about routine maintenance...

call 1-866-986-3223, Monday - Friday, 8 am to 9 pm, EST.

Troubleshooting Guide

Need help troubleshooting? Call 1-866-986-3223, Monday - Friday, 8 am to 9 pm, EST.

Tools Needed For Most Repairs: 5/16 Hex Driver, Phillips Screwdriver, Needle – nose Pliers

PROBLEM	CAUSE	SOLUTION
No Soft Water	1. No salt in the storage tank.	a. Refill with salt. b. Use Recharge feature.
No Soft Water Timer Display Blank	1. Transformer unplugged at wall outlet, or power cable disconnected from back of electronic board, transformer defective.	a. Check for loss of power and correct. Reset electronic controls and use the Recharge feature.
	2. Fuse blown, circuit breaker popped, or circuit switched off. (See page 24 "Power Outage Memory").	a. Replace fuse, reset circuit breaker, or switch circuit on use the Recharge feature.
	3. Electronic control board defective.	a. Replace Electronic Control Board (PWA). *
No Soft Water Salt Level Not Dropping	1. Salt in storage tank bridged.	a. Refer to "Breaking a Salt Bridge" section to break.
	2. Manual bypass valve(s) in bypass position.	a. Move stem in single valve bypass to service.
No Soft Water, Salt Storage Tank Full Of Water	1. Dirty, plugged or damaged nozzle & venturi.	a. Take apart, clean and inspect nozzle and venturi, see "Cleaning the Nozzle and Venturi" section.
	2. Valve drain hose plugged.	a. Hose must not have any kinks, sharp bends or any water flow blockage, see "Valve Drain Requirements" section.
	3. Low or high system water pressure (low pressure may disrupt brine draw during recharge, high pressures may cause inner valve parts failure).	a. If pressure is low, increase well pump output to a minimum 20 psi. Add a pressure reducing valve in the supply pipe to the softener, if daytime pressure is over 100 psi. Contact a licensed plumber.
	4. Brine valve float dirty or defective.	a. Clean or replace Brine Valve Float assembly. *
	5. Leak between valve and resin tank assembly.	a. Replace o-rings between resin tank and valve. See water softener components.
Water Hard Sometimes	1. Time setting wrong.	a. Check and change time setting.
	2. Incorrect water hardness setting.	a. Refer to "Set Water Hardness Number" section to set correctly.
	3. Incorrect model code programmed.	a. Refer to "Program The Water Softener" section to set correctly.
	4. Hot water being used when softener is regenerating.	a. Avoid using hot water while the softener is regenerating as the water heater will fill with hard water.
	5. Possible increase in water hardness.	a. Test the raw water for hardness and iron and program the water softener accordingly, see "Set Water Hardness Number" section to set.
	6. Leaking faucet or toilet valve. Excessive water usage.	a. A small leak will waste hundreds of gallons of water in a few days. Fix all leaks and always fully close faucets.
Iron In Water	1. Clear water iron in water supply.	a. Test the raw water for hardness and iron and program the water softener accordingly see "Set Water Hardness Number" section to set.
	2. Iron in soft water.	a. Clean resin bed with Resin Bed Cleaner. Follow instructions on package.
	3. Bacterial or organic bound iron.	a. Cannot be treated by water softener.
Motor Stalled Or Clicking	1. Motor defective or inner valve defect causing high torque on motor.	a. Replace rotor/seal kit.* b. Replace motor & switch. See water softener components.
Error Code E1, E3, or E4 appears	1. Wiring Harness or Connection to Position Switch.	a. Replace wiring harness or connection to position switch. See water softener components.
	2. Switch.	a. Replace switch. See water softener components.
	3. Valve Defect Causing High Torque.	a. Replace rotor/seal kit.*
	4. Motor Inoperative.	a. Replace motor. *
Error Code E5 appears	1. Electronic Control.	a. Replace Electronic Control Board (PWA). *

Assistance from customer service may be needed with the following problems and solutions.

PROBLEM	CAUSE	SOLUTION
Water Running To The Drain (While Unit Is In The Soft Water Cycle)	1. Inner valve defect causing leak.	a. Replace seals and rotor.
Resin In Household Plumbing, Resin Tank Leaking	1. Crack in distributor or riser tube.	a. Replace distributor or riser tube.
Salt Storage Tank Leaking	1. Crack in brine tank.	a. Replace salt storage tank.

* Instructions included.

Procedure for removing error code from faceplate:

1. Unplug transformer from outlet.
2. Correct defect.
3. Plug in transformer.
4. Wait for 6 minutes. The error code will return if the defect was not corrected.

Automatic Electronic Diagnostics

This water softener has a self-diagnostic function for the electrical system (except input power and/or water meter). The water softener monitors electronic components and circuits for correct operation. If a malfunction occurs, an error code appears in the display.

The troubleshooting chart shows the error codes that could appear, and the possible malfunctions for each code.

While an error code appears in the display, all buttons are inoperable except the PROGRAM button. PROGRAM remains operational so the service person can perform the Manual Advance Diagnostics, see below, to further isolate the problem.

Manual Advance Diagnostics – Model WHES20

Use the following procedures to advance the water softener through the regeneration cycles to check operation.

Lift off the salt hole cover, remove the top cover by unlocking the tabs in the back and rocking forward, to observe cam and switch operation during valve rotation.

1. Press and hold  PROGRAM for 3 seconds until 000 - - shows in the display.

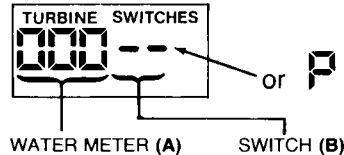

2. The first 3 digits indicate water meter operation as follows:
000 (steady) = Soft water not in use, and no flow through the meter.
Open a nearby soft water faucet.
000 to 199 (continual) = Repeats display for each gallon of water passing through the meter.

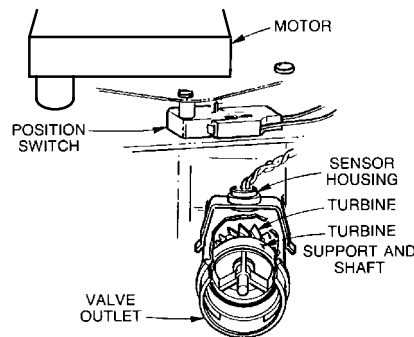

NOTE: If you don't get a reading in the display, with faucet open, pull the sensor from the valve outlet port. Pass a small magnet back and forth in front of the sensor. If you get a reading in the display with the magnet, unhook the in and out plumbing and check the turbine for binding.



3. The letter (P) and dash (or dashes) indicate POSITION switch operation. If the letter appears, the switch is closed. If the dash shows, the switch is open.
4. Use the  RECHARGE button to manually advance the valve into each cycle and check correct switch operation.





NOTE: Be sure water is in contact with the salt, and not separated by a salt bridge... see "Breaking A Salt Bridge" section.

5. While in this diagnostic screen, the following information is available and may be beneficial for various reasons. This information is retained by the computer from the first time electrical power is applied to the face plate.

- Press  Up to display the number of days this electronic control has had electrical power applied.
 - Press  Down to display the number of regenerations initiated by this electronic control since the SR code number was entered.
6. Press and hold the  PROGRAM button until SR17 shows in the display.





This code identifies the softener model. If the wrong number shows, the softener will operate on incorrect programming.

7. Return the present time display — Press the  PROGRAM button.
8. To change SR number — Press the  Up or  Down button until the correct SR code shows. Then, press the  PROGRAM button to return to the present time display.

Manual Advance Regeneration Check – Model WHES20

This check verifies proper operation of the valve motor, brine tank fill, brine draw, regeneration flow rates, and other controller functions. Always make the initial checks, and the manual initiated diagnostics.

NOTE: The electronic control display must show a steady time (not flashing). If an error code shows, first press the  PROGRAM button to enter the diagnostic display.

1. Press the  RECHARGE button and hold in for 3 seconds. RECHARGE begins to flash as the softener enters the fill cycle of regeneration. Remove the brinewell cover and, using a flashlight, observe fill water entering the tank.

If water does not enter the tank, look for an obstructed nozzle, venturi, fill flow plug, brine tubing, or brine valve riser pipe.

2. After observing fill, press the  RECHARGE button to move the softener into brining. A slow flow of water to the drain will begin. Verify brine draw from the brine tank by shining a flashlight into the brinewell and observing a noticeable drop in the liquid level. This may take 15 to 20 minutes to notice.

NOTE: Be sure water is in contact with the salt, and not separated by a salt bridge... see “Breaking A Salt Bridge” section.



If the water softener does not draw brine, check for (most likely to least likely)

- Dirty or plugged nozzle and venturi, see “Cleaning the Nozzle and Venturi” section
- Nozzle and venturi not seated on the gasket, or gasket deformed
- Restriction in valve drain, causing a back-pressure (bends, kinks, elevated too high, etc.), see “Install Valve Drain Hose” section
- Obstruction in brine valve or brine tubing
- Inner valve failure (obstructed outlet disc, wave washer deformed, etc.)

NOTE: If water system pressure is low, an elevated drain hose may cause back pressure, stopping brine draw.

3. Again, press the  RECHARGE button to move the softener into backwash. Look for a fast flow of water from the drain hose.

An obstructed flow indicates a plugged top distributor, backwash flow plug, or drain hose.

4. Press the  RECHARGE button to move the softener into fast rinse. Again look for a fast drain flow. Allow the softener to rinse for a few minutes to flush out any brine that may remain in the resin tank from the brining cycle test.
5. To return the softener to service, press the  RECHARGE button.

Manual Advance Diagnostics – Model WHES30

Use the following procedures to advance the water softener through the regeneration cycles to check operation.

Lift off the salt hole cover, remove the top cover by unlocking the tabs in the back and rocking forward, to observe cam and switch operation during valve rotation.

1. Press and hold  PROGRAM for 3 seconds until 000 - - shows in the display.



2. The first 3 digits indicate water meter operation as follows:
 - 000 (steady) = Soft water not in use, and no flow through the meter. Open a nearby soft water faucet.
 - 000 to 199 (continual) = Repeats display for each gallon of water passing through the meter.

NOTE: If you don't get a reading in the display, with faucet open, pull the sensor from the valve outlet port. Pass a small magnet back and forth in front of the sensor. You should get a reading in the display. If you get a reading, unhook the in and out plumbing and check the turbine for binding.

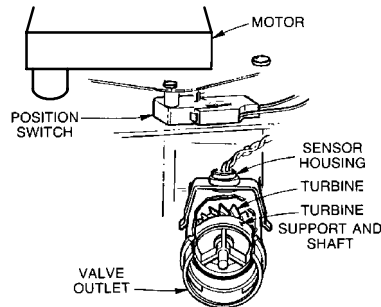

3. Symbols in the display indicate POSITION switch operation.





4. Use the  RECHARGE button to manually advance the valve into each cycle and check correct switch operation.

NOTE: Be sure water is in contact with the salt, and not separated by a salt bridge... see "Breaking A Salt Bridge" section.



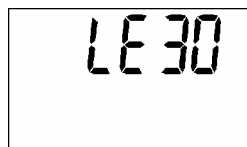

5. While in this diagnostic screen, the following information is available and may be beneficial for various reasons. This information is retained by the computer from the first time electrical power is applied to the face plate.

- Press  Up to display the number of days this electronic control has had electrical power applied.

-
- Press  Down to display the number of regenerations initiated by this electronic control since the LE code number was entered.
6. Press and hold the  PROGRAM button until LE30 shows in the display.





This code identifies the softener model. If the wrong number shows, the softener will operate on incorrect programming.

7. Return the present time display — Press the  PROGRAM button.
8. To change LE number — Press the  Up or  Down button until the correct code shows. Then, press the  PROGRAM button to return to the present time display.

Manual Advance Regeneration Check – Model WHES30

This check verifies proper operation of the valve motor, brine tank fill, brine draw, regeneration flow rates, and other controller functions. Always make the initial checks, and the manual initiated diagnostics.

NOTE: The electronic control display must show a steady time (not flashing). If an error code shows, first press the  PROGRAM button to enter the diagnostic display.

1. Press the  RECHARGE button and hold in for 3 seconds. RECHARGE begins to flash as the softener enters the fill cycle of regeneration. Remove the brinewell cover and, using a flashlight, observe fill water entering the tank.

If water does not enter the tank, look for an obstructed nozzle, venturi, fill flow plug, brine tubing, or brine valve riser pipe.

2. After observing fill, press the  RECHARGE button to move the softener into brining. A slow flow of water to the drain will begin. Verify brine draw from the brine tank by shining a flashlight into the brinewell and observing a noticeable drop in the liquid level. This may take 15 to 20 minutes to notice.

NOTE: Be sure water is in contact with the salt, and not separated by a salt bridge... see “Breaking A Salt Bridge” section.

If the water softener does not draw brine, check for (most likely to least likely)

- Dirty or plugged nozzle and venturi, see “Cleaning the Nozzle and Venturi” section
- Nozzle and venturi not seated on the gasket, or gasket deformed
- Restriction in valve drain, causing a back-pressure (bends, kinks, elevated too high, etc.), see “Install Valve Drain Hose” section
- Obstruction in brine valve or brine tubing
- Inner valve failure (obstructed outlet disc, wave washer deformed, etc.)

NOTE: If water system pressure is low, an elevated drain hose may cause back pressure, stopping brine draw.

3. Again, press the  RECHARGE button to move the softener into backwash. Look for a fast flow of water from the drain hose.

An obstructed flow indicates a plugged top distributor, backwash flow plug, or drain hose.

4. Press the RECHARGE button to move the softener into fast rinse. Again look for a fast drain flow. Allow the softener to rinse for a few minutes to flush out any brine that may remain in the resin tank from the brining cycle test.
5. To return the softener to service, press the RECHARGE button.

Product Specifications

	WHES20	WHES30
Rated Service Flow Rate (gpm)	7.0	8.3
Amount of High Capacity Resin (cu ft)	.6	.82
Pressure Drop at Rated Service Flow (psig)	12	15
Water Supply Max. Hardness (gpg)	50	95
Water Supply Max. Clear Water Iron (ppm)	3	7
Water Pressure Limits (min./max. psi)	20 – 125	20 – 125
Min. – Max. Water Temperature (°F)	40 – 120	40 – 120
Min. Water Supply Flow Rate (gpm)	3	3
Max. Drain Flow Rate (gpm)	2.2	2.2
Salt storage capacity	200 lbs.	200 lbs.

Performance Claims

	WHES20	WHES30
Rated Softening Capacity (Grains/Pounds of Salt)	9,000 @ 1.8 13,600 @ 3.5 17,800 @ 6.5 20,100 @ 9.4	13,500 @ 2.5 20,400 @ 4.9 26,800 @ 9.0 30,100 @ 13.1
Rated Efficiency (Grains/Pound of Salt @ Minimum Salt Dose)	5000 @1.8 lbs.	5,100 @2.5 lbs.

These systems conform to NSF/ANSI 44 for the specific performance claims as verified and substantiated by test data.

The efficiency rating is only valid at the stated salt dose. These softeners were efficiency rated according to NSF/ANSI Standard 44.

Variable Salt Dose

The salt dose is selected by the electronic controls at regeneration time based on the amount needed.

Wiring Schematic

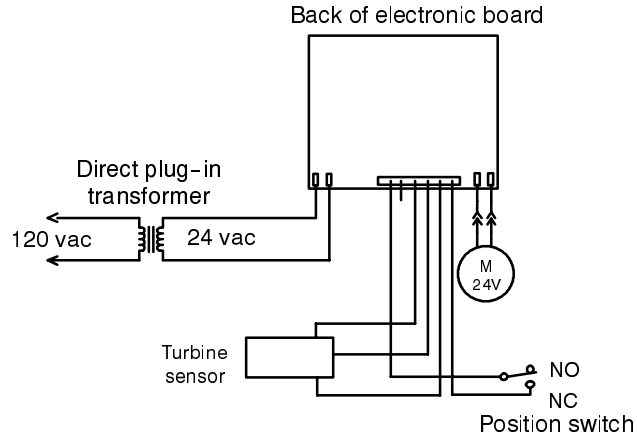

Warranty

WATER SOFTENER WARRANTY

Warrantor: Ecodyne Water Systems Inc., 1890 Woodlane Drive, Woodbury, MN 55125

Warrantor guarantees, to the original owner, that:

One Year Full Warranty:

For a period of one (1) year after installation, all parts will be free of defects in materials and workmanship and will perform their normal functions.

For a period of one (1) year after installation, labor to repair or replace any part deemed to be defective in materials or workmanship, will be provided at no additional cost.

Limited Warranties:

Limited ten (10) year warranty, from date of purchased, the salt storage tank and fiberglass mineral tank will not rust, corrode, leak, burst, or in any other manner, fail to perform their proper functions; and that

Limited three (3) year warranty, after installation, the electronic control board will be free of defects in materials and workmanship and will perform its normal functions.

If, during such respective period, a part proves to be defective, Warrantor will ship a replacement part, directly to your home, without charge. After the first year, labor necessary to maintain this product is not covered by the product warranty.

If you have questions regarding a warranted product, need assistance with installation or trouble shooting, wish to order a part or report a warranty issue, we are just a phone call away. Simply dial 1-866-986-3223, Monday - Friday, 8 am - 9 pm EST, for assistance.

General Provisions

The above warranties are effective provided the water conditioner is operated at water pressures not exceeding 125 psi, and at water temperatures not exceeding 120°F; provided further that the water conditioner is not subject to abuse, misuse, alteration, neglect, freezing, accident or negligence; and provided further that the water conditioner is not damaged as the result of any unusual force of nature such as, but not limited to, flood, hurricane, tornado or earthquake.

Warrantor is excused if failure to perform its warranty obligations is the result of strikes, government regulation, materials shortages, or other circumstances beyond its control.

***THERE ARE NO WARRANTIES ON THE WATER CONDITIONER BEYOND THOSE SPECIFICALLY DESCRIBED ABOVE. ALL IMPLIED WARRANTIES, INCLUDING ANY IMPLIED WARRANTY OF MERCHANTABILITY OR OF FITNESS FOR A PARTICULAR PURPOSE, ARE DISCLAIMED TO THE EXTENT THEY MIGHT EXTEND BEYOND THE ABOVE PERIODS. THE SOLE OBLIGATION OF WARRANTOR UNDER THESE WARRANTIES IS TO REPLACE OR REPAIR THE COMPONENT OR PART WHICH PROVES TO BE DEFECTIVE WITHIN THE SPECIFIED TIME PERIOD, AND WARRANTOR IS NOT LIABLE FOR CONSEQUENTIAL OR INCIDENTAL DAMAGES. NO WARRANTOR DEALER, AGENT, REPRESENTATIVE, OR OTHER PERSON IS AUTHORIZED TO EXTEND OR EXPAND THE WARRANTIES EXPRESSLY DESCRIBED ABOVE.**

Some states do not allow limitations on how long an implied warranty lasts or exclusions or limitations of incidental or consequential damage, so the limitations and exclusions in this warranty may not apply to you. This warranty gives you specific legal rights, and you may have other rights which vary from state to state. This warranty applies to consumer-owned installations only.

® Registered trademark/TM Trademark of Whirlpool, USA, used under license.

© 2004 Whirlpool Corporation. All rights reserved.

TEFLON is a registered trademark of E. I. DuPont.

Softener Components

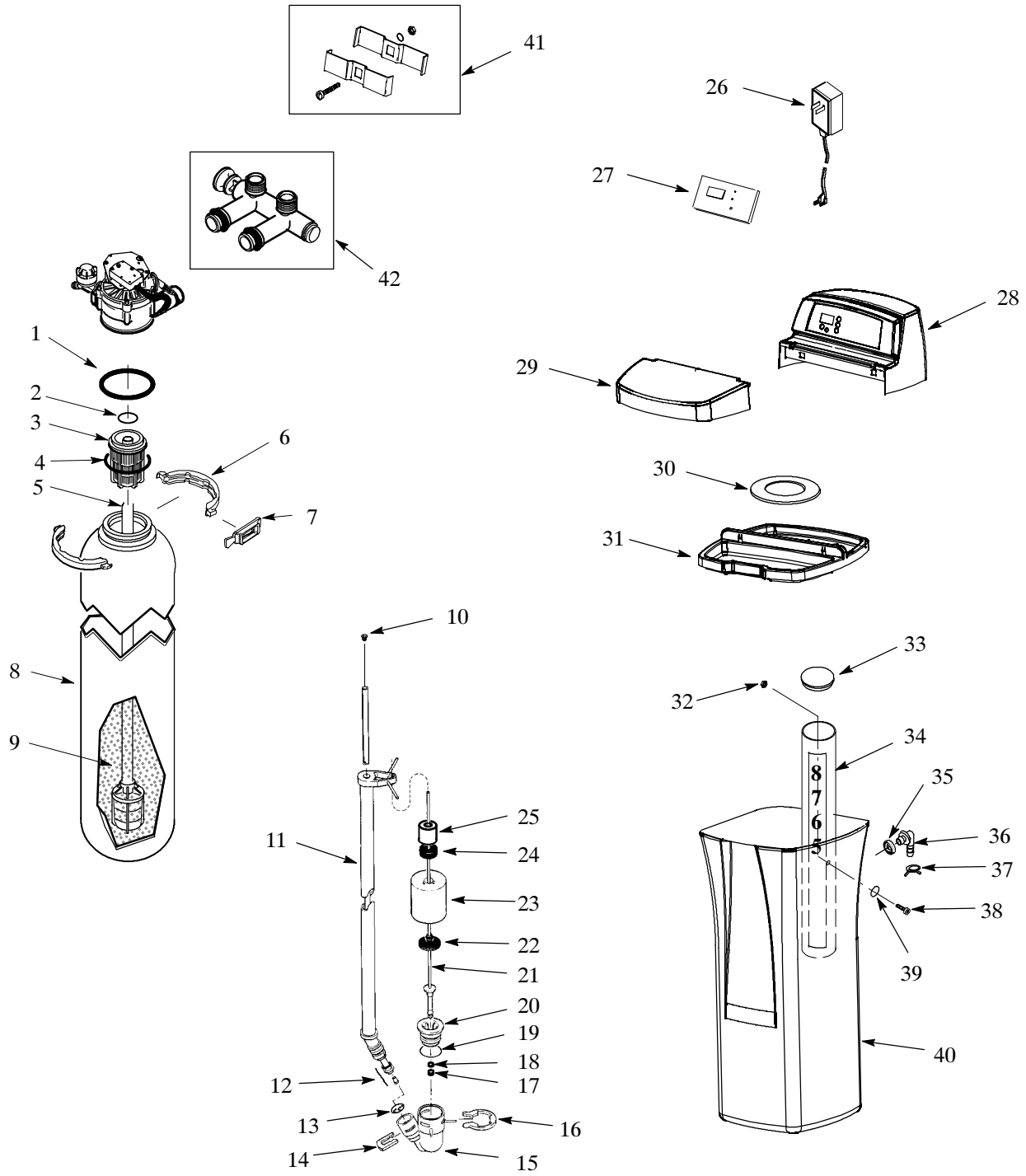

Softener Components

Key No.	Part No.	Description
1	7170296	O-Ring, 2-7/8" x 3-1/4"
2	7170254	O-Ring, 13/16" x 1-1/16"
3	7077870	Top Distributor
4	7170270	O-Ring, 2-3/4" x 3"
5	7105047	Rep'l Bottom Distributor
6	7176292	Clamp Section (2 req.)
7	7088033	Retainer Clip (2 req.)
8	7114787	Rep'l Resin Tank, Model WHES20
	7264922	Rep'l Resin Tank, Model WHES30
9	0502272	Resin, 1 cu. ft.
10	7171349	Cone Screen
11	7095470	Brine Tube
12	7113016	Tubing Assembly
13	7131365	Screen
14	7080653	Clip
15	7092252	Brine Valve Body
16	1205500	Clip
17	0516924	Bottom Seal Retainer
18	0516211	Seal
19	7170288	O-Ring, 15/16 x 1-3/16
20	7092278	Guide Cap
21	7093216	Float Rod & Stem, Model WHES20
	7220627	Float Rod & Stem, Model WHES30
22	0516947	Float Seal
23	7097202	Float (includes Key No. 22)
24	0513860	Float Stop
25	7168647	Ceramic Weight
-	7116488	Rep'l Brine Valve Asm., Model WHES20
	7239155	Rep'l Brine Valve Asm., Model WHES30

Key No.	Part No.	Description
26	7252373	Transformer
27	7264891	Rep'l Electronic Control Board (PWA), Model WHES20
	7264906	Rep'l Electronic Control Board (PWA), Model WHES30
28	7267108	Top Cover & Faceplate Asm, Model WHES20 (order decal, below)
	7262831	Faceplate Decal, Model WHES20
	7267116	Top Cover & Faceplate Asm, Model WHES30 (order decal, below)
	7262849	Faceplate Decal, Model WHES30
29	7262661	Salt Hole Cover
30	7163689	Vapor Barrier
31	7262653	Rim
32	7082150	Nut
33	7155115	Brinewell Cover
34	7109871	Brinewell, Model WHES20
	7214375	Brinewell, Model WHES30
35	9003500	Grommet
36	1103200	Hose Adaptor
37	0900431	Hose Clamp
38	7262792	Screw
39	7003847	O-Ring
40	7264875	Rep'l Brine Tank
41	7248706	Grounding Kit
42	7129871	Bypass Valve

Softener Components

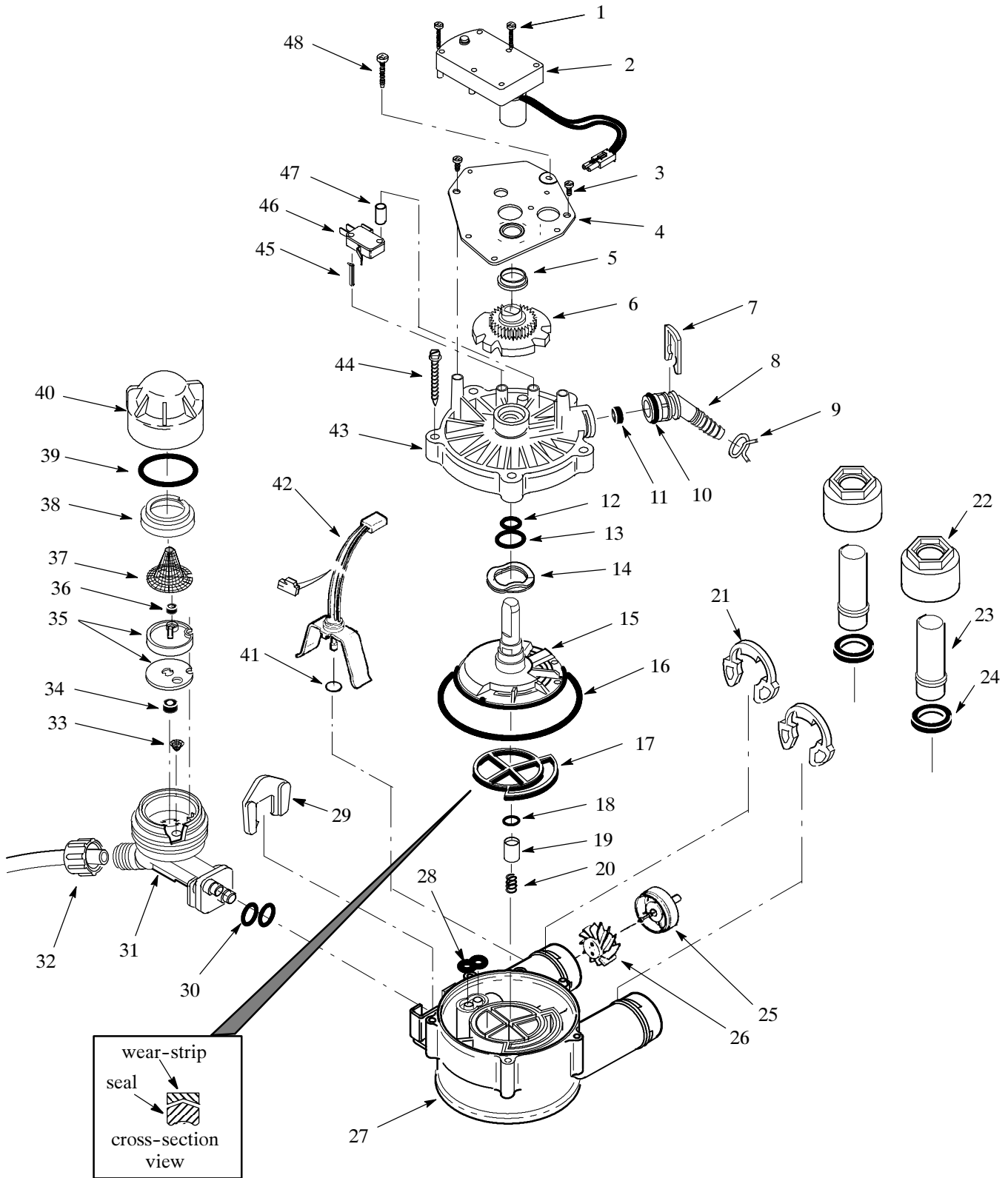

Softener Components

Key No.	Part No.	Description
1	7224087	Screw, #8-32 x 1" (2 req.)
2	7228544	Motor (incl. 2 ea. of Key No. 1)
3	0900857	Screw, #6-20 x 3/8 (2 req.)
4	7231385	Motor Plate
5	0503288	Bearing
6	7113927	Cam and Gear
7	7142942	Clip (Drain)
8	7024160	Drain Hose Adaptor
9	0900431	Tubing Clamp
10	7170327	O-Ring, 5/8 x 13/16
11	0501228	Flow Plug
12	7170238	O-Ring, 7/16 x 5/8
13	7170212	O-Ring, 3/4 x 15/16
14	7082087	Wave Washer
15	7199232	Rotor & Disc
16	7170246	O-Ring, 3-3/8 x 3-5/8
17	7134224	Rotor Seal
18	7170204	O-Ring, 3/8 x 9/16
19	7092642	Plug (Drain Seal)
20	7129889	Spring
21	7116713	Clip (2 req.)
22	0507369	Installation Nut (2 req.)
23	0507615	Installation Tube (2 req.)
24	7170335	Washer (2 req.)
25	2204101	Turbine Support and Shaft
26	7117858	Turbine
27	7082053	Valve Body
28	7081764	Seal (Nozzle & Venturi)
29	7081201	Retainer (Nozzle & Venturi)

Key No.	Part No.	Description
30	7170319	O-Ring, 1/4 x 3/8 (2 req.)
31	7081104	Nozzle & Venturi Housing
32	1202600	Nut - Ferrule
33	7095030	Cone Screen
34	1148800	Flow Plug, .3 gpm
35	7248007	Nozzle & Venturi Gasket Kit, Model WHES20
	7190547	Gasket (only), Model WHES20
	7114533	Nozzle & Venturi Gasket Kit, Model WHES30
	7204362	Gasket (only), Model WHES30
36	0521829	Flow Plug, .1 gpm, Model WHES20
	7084607	Flow Plug, .15 gpm, Model WHES30
37	7146043	Screen
38	7167659	Screen Support
39	7170262	O-Ring, 1-1/8" x 1-3/8"
40	7199729	Cap
41	0900060	O-Ring
42	7248714	Sensor Housing & Wiring Harness
43	7085263	Valve Cover
44	7074123	Screw, #10-14 x 2 (5 req.)
45	7077472	Expansion Pin
46	7030713	Switch
47	7117816	Spacer
48	7070412	Screw, #4-24 x 1-1/8 (flat head)
◆	7187065	Nozzle & Venturi Asm. (incl. Key Nos. 31, & 33 - 40), Model WHES20
◆	7253808	Nozzle & Venturi Asm. (incl. Key Nos. 31, & 33 - 40), Model WHES30

◆ Not shown.

Manufactured and warranted by
Ecodyne Water Systems, Inc.
1890 Woodlane Drive
Woodbury, MN 55125

